

===== TForce P965 Deluxe / TForce 965PT =====
Setup Manual

FCC Information and Copyright

This equipment has been tested and found to comply with the limits of a Class B digital device, pursuant to Part 15 of the FCC Rules. These limits are designed to provide reasonable protection against harmful interference in a residential installation. This equipment generates, uses and can radiate radio frequency energy and, if not installed and used in accordance with the instructions, may cause harmful interference to radio communications. There is no guarantee that interference will not occur in a particular installation.

The vendor makes no representations or warranties with respect to the contents here and specially disclaims any implied warranties of merchantability or fitness for any purpose. Further the vendor reserves the right to revise this publication and to make changes to the contents here without obligation to notify any party beforehand.

Duplication of this publication, in part or in whole, is not allowed without first obtaining the vendor's approval in writing.

The content of this user's manual is subject to be changed without notice and we will not be responsible for any mistakes found in this user's manual. All the brand and product names are trademarks of their respective companies.

Table of Contents

Chapter 1: Introduction	1
1.1 Before You Start	1
1.2 Package Checklist(TForce P965 Deluxe)	1
1.3 Package Checklist(TForce 965PT)	1
1.4 Motherboard Features	2
1.5 Rear Panel Connectors	3
1.6 Motherboard Layout(TForce P965 Deluxe)	4
1.7 Motherboard Layout(TForce 965PT)	5
Chapter 2: Hardware Installation	6
2.1 Installing Central Processing Unit (CPU)	6
2.2 FAN Headers	8
2.3 Installing System Memory	9
2.4 Connectors and Slots	11
Chapter 3: Headers & Jumpers Setup	13
3.1 How to Setup Jumpers	13
3.2 Detail Settings	13
Chapter 4: Intel RAID Functions (for TForce P965 Deluxe)	20
4.1 Operation System	20
4.2 Raid Arrays	20
4.3 How RAID Works	20
Chapter 5: OverClock Quick Guide	25
5.1 T-Power Introduction	25
5.2 T-Power BIOS Feature	26
5.3 T-Power Windows Feature	34
Chapter 6: Useful Help	43
6.1 Driver Installation Note	43
6.2 Award BIOS Beep Code	44
6.3 Extra Information	44
6.4 Troubleshooting	46
Appendicies: SPEC In Other Language	48
German	48
France	50
Italian	52
Spanish	54
Portuguese	56
Polish	58
RUSSIAN	60
ARABIC	62
JAPANESE	64

CHAPTER 1: INTRODUCTION

1.1 BEFORE YOU START

Thank you for choosing our product. Before you start installing the motherboard, please make sure you follow the instructions below:

- Prepare a dry and stable working environment with sufficient lighting.
- Always disconnect the computer from power outlet before operation.
- Before you take the motherboard out from anti-static bag, ground yourself properly by touching any safely grounded appliance, or use grounded wrist strap to remove the static charge.
- Avoid touching the components on motherboard or the rear side of the board unless necessary. Hold the board on the edge, do not try to bend or flex the board.
- Do not leave any unfastened small parts inside the case after installation. Loose parts will cause short circuits which may damage the equipment.
- Keep the computer from dangerous area, such as heat source, humid air and water.

1.2 PACKAGE CHECKLIST (TFORCE P965 DELUXE)

- ✦ FDD Cable X 1
- ✦ HDD Round Cable X 1
- ✦ Serial ATA Cable X 4
- ✦ Serial ATA Power Cable X 4
- ✦ Rear I/O Panel for ATX Case X 1
- ✦ User's Manual X 1
- ✦ Fully Setup Driver CD X 1
- ✦ S/PDIF out Cable X 1
- ✦ USB 2.0 Cable X1 (optional)

1.3 PACKAGE CHECKLIST (TFORCE 965PT)

- ✦ FDD Cable X 1
- ✦ HDD Cable X 1
- ✦ Serial ATA Cable X 1
- ✦ Serial ATA Power Cable X 1
- ✦ Rear I/O Panel for ATX Case X 1
- ✦ User's Manual X 1
- ✦ Fully Setup Driver CD X 1
- ✦ USB 2.0 Cable X1 (optional)
- ✦ S/PDIF out Cable X 1 (optional)

1.4 MOTHERBOARD FEATURES

	<i>TForce P965 Deluxe</i>	<i>TForce 965PT</i>
CPU	LGA 775 Intel Core2Duo / Pentium D/Pentium 4 / Celeron D processor up to 3.8 GHz Supports Hyper Transport/ Execute Disable Bit/ Enhanced Intel SpeedStep®/ Intel Extended Memory 64 technology	LGA 775 Intel Core2Duo / Pentium D/Pentium 4 / Celeron D processor up to 3.8 GHz Supports Hyper Transport/ Execute Disable Bit/ Enhanced Intel SpeedStep®/ Intel Extended Memory 64 technology
FSB	533 / 800 / 1066 MHz	533 / 800 / 1066 MHz
Chipset	Intel P965 Intel ICH8R	Intel P965 Intel ICH8
Super I/O	ITE IT8718F Provides the most commonly used legacy Super I/O functionality Low Pin Count Interface Environment Control initiatives, H/W Monitor Fan Speed Controller ITE's "Smart Guardian" function	ITE IT8718F Provides the most commonly used legacy Super I/O functionality Low Pin Count Interface Environment Control initiatives, H/W Monitor Fan Speed Controller ITE's "Smart Guardian" function
Main Memory	DIMM Slots x 4 Each DIMM supports 256MB / 512MB / 1GB / 2GB DDR2 Max Memory Capacity 8GB Dual Channel Mode DDR2 memory module Supports DDR2 533 / 667 / 800 Registered DIMM and ECC DIMM is not supported	DIMM Slots x 4 Each DIMM supports 256MB / 512MB / 1GB / 2GB DDR2 Max Memory Capacity 8GB Dual Channel Mode DDR2 memory module Supports DDR2 533 / 667 / 800 Registered DIMM and ECC DIMM is not supported
IDE	VIA VT6410 Ultra DMA 33 / 66 / 100 / 133 Bus Master Mode supports PIO Mode 0~4,	VIA VT6410 Ultra DMA 33 / 66 / 100 / 133 Bus Master Mode supports PIO Mode 0~4,
SATA 2	Integrated Serial ATA Controller Data transfer rates up to 3.0 Gb/s. SATA Version 2.0 specification compliant.	Integrated Serial ATA Controller Data transfer rates up to 3.0 Gb/s. SATA Version 2.0 specification compliant.
LAN	Realtek RTL 8110SC 10 / 100 Mb/s and 1Gb/s auto negotiation Half / Full duplex capability	Realtek RTL 8110SC 10 / 100 Mb/s and 1Gb/s auto negotiation Half / Full duplex capability
Sound Codec	ALC883 8+2 channels audio out High Definition Audio	ALC883 8+2 channels audio out High Definition Audio
Slots	PCI slot x3 PCI Express x 16 slot x1 PCI Express x 4 slot x1 PCI Express x 1 slot x1	PCI slot x3 PCI Express x 16 slot x1 PCI Express x 4 slot x1 PCI Express x 1 slot x1
On Board Connector	Floppy connector x1 Printer Port Connector x1 IDE Connector x1	Floppy connector x1 Printer Port Connector x1 IDE Connector x1

TForce P965 Deluxe/TForce 965PT

	<i>TForce P965 Deluxe</i>	<i>TForce 965PT</i>
	SATA Connector x6	SATA Connector x4
	Front Panel Connector x1	Front Panel Connector x1
	Front Audio Connector x1	Front Audio Connector x1
	CD-in Connector x1	CD-in Connector x1
	S/PDIF out connector x1	S/PDIF out connector x1
	S/PDIF in connector x1	S/PDIF in connector x1
	CPU Fan header x1	CPU Fan header x1
	System Fan header x2	System Fan header x2
	Clear CMOS header x1	Clear CMOS header x1
	USB connector x2	USB connector x2
	Power Connector (24pin) x1	Power Connector (24pin) x1
	Power Connector (4pin) x1	Power Connector (4pin) x1
Back Panel I/O	PS/2 Keyboard x1	PS/2 Keyboard x1
	PS/2 Mouse x1	PS/2 Mouse x1
	Serial Port x1	Serial Port x1
	LAN port x1	LAN port x1
	USB Port x6	USB Port x6
	Audio Jack x6	Audio Jack x6
Board Size	220 (W) x 305 (L) mm	220 (W) x 305 (L) mm
	ATX form Factor	ATX form Factor
Special Feature	RAID 0 / 1 / 5 / 1+0 support	
OS Support	Windows 2000 / XP	Windows 2000 / XP
	Biostar Reserves the right to add or remove support for any OS with or without notice.	Biostar Reserves the right to add or remove support for any OS with or without notice.

1.5 REAR PANEL CONNECTORS

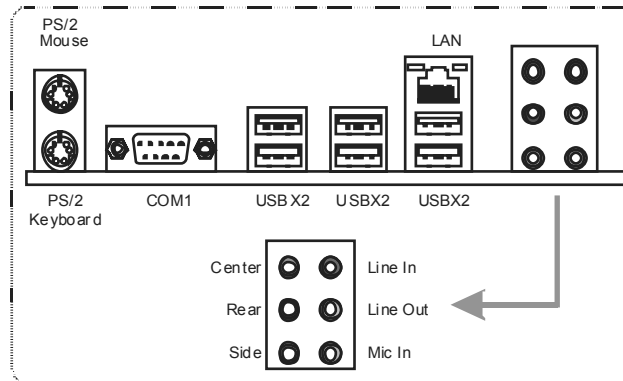

Since the audio chip supports Intel High Definition Audio Specification, the function of each audio jack can be defined by software. The input / output function of each audio jack listed above represents the default setting. However, when connecting external microphone to the audio port, please use the Line In (blue) and Mic In (pink) audio jack.

1.6 MOTHERBOARD LAYOUT (TFORCE P965 DELUXE)

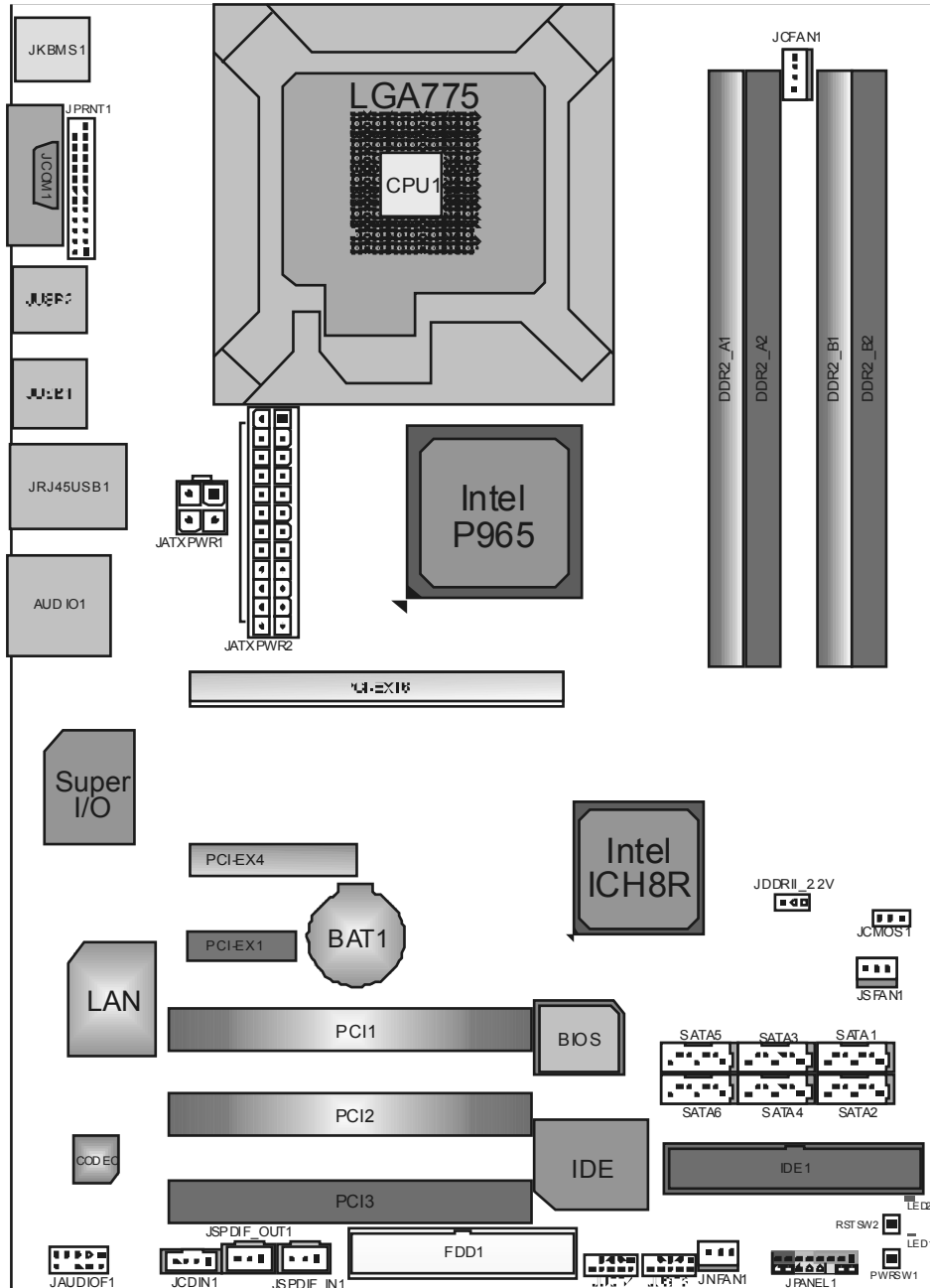

Note: ■ represents the 1st pin.

1.7 MOTHERBOARD LAYOUT (TForce 965PT)

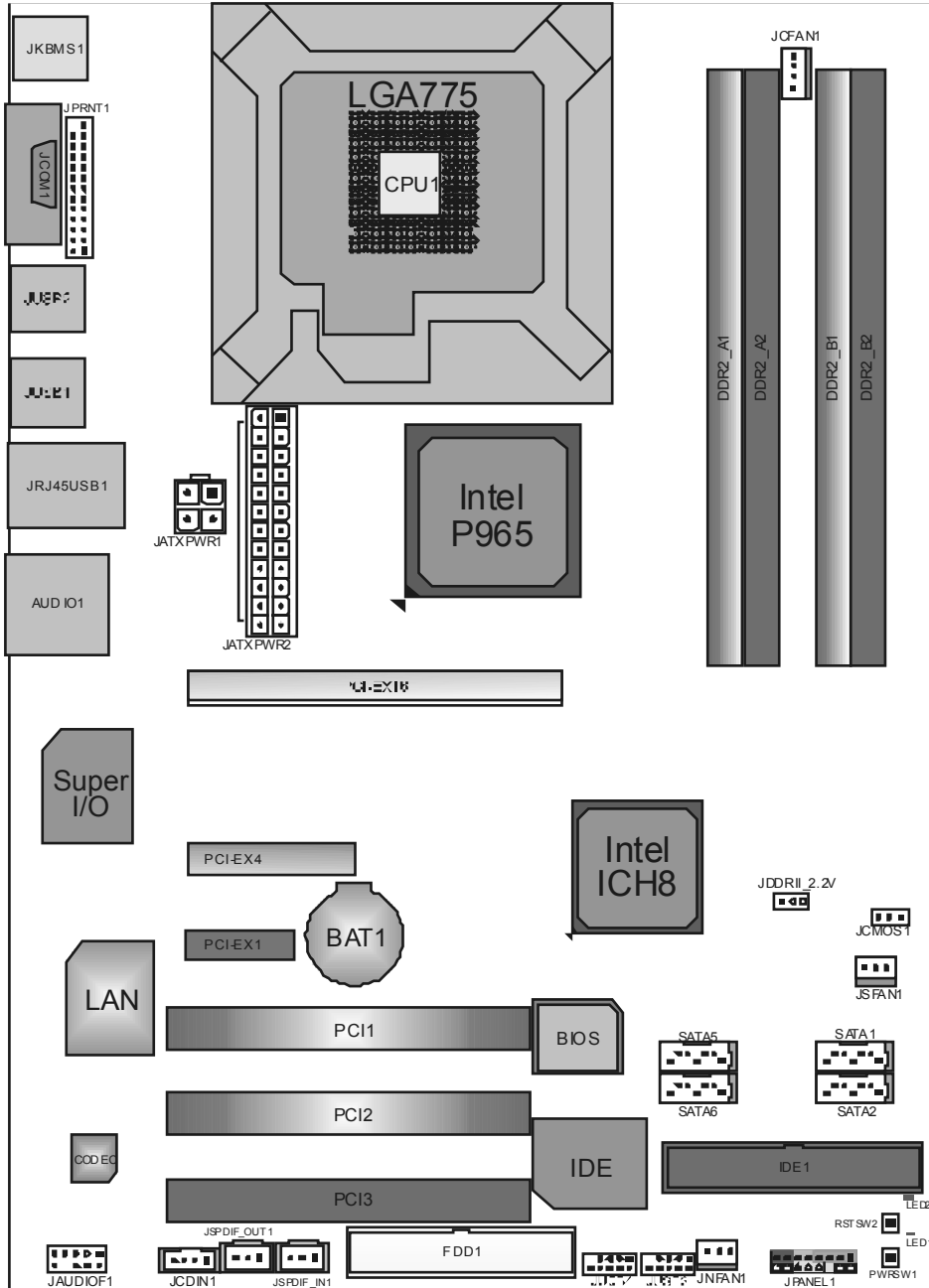

Note: ■ represents the 1st pin.

CHAPTER 2: HARDWARE INSTALLATION

2.1 INSTALLING CENTRAL PROCESSING UNIT (CPU)

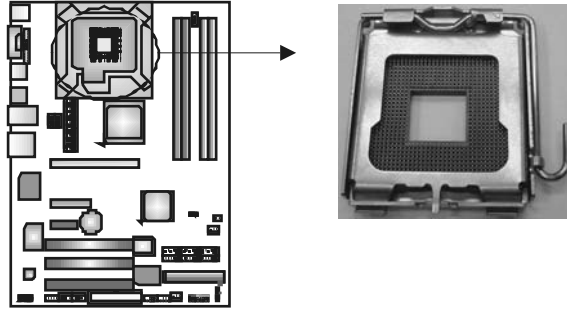

Special Notice

Remove Pin Cap before installation, and make good preservation for future use. When the CPU is removed, cover the Pin Cap on the empty socket to ensure pin legs won't be damaged.

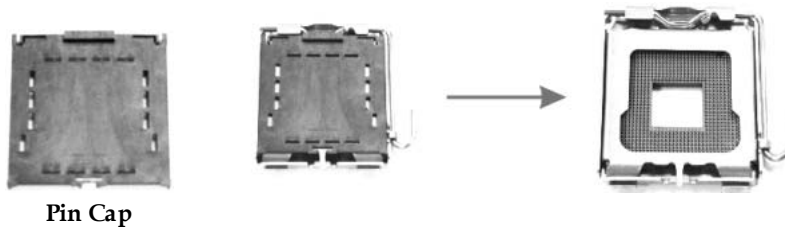

Step 1: Pull the socket locking lever out from the socket and then raise the lever up to a 90-degree angle.

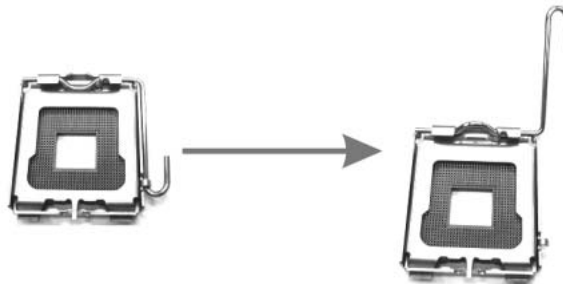

TForce P965 Deluxe/TForce 965PT

Step 2: Look for the triangular cut edge on socket, and the golden dot on CPU should point forwards this triangular cut edge. The CPU will fit only in the correct orientation.

Step 2-1:

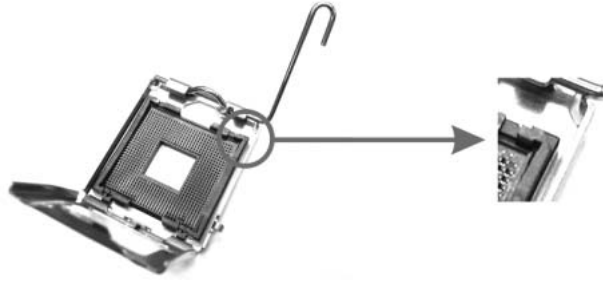

Step 2-2:

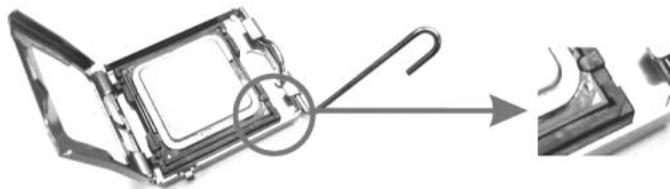

Step 3: Hold the CPU down firmly, and then lower the lever to locked position to complete the installation.



Step 4: Put the CPU Fan and heatsink assembly on the CPU and buckle it on the retention frame. Connect the CPU FAN power cable into the JCFAN1. This completes the installation.

2.2 FAN HEADERS

These fan headers support cooling-fans built in the computer. The fan cable and connector may be different according to the fan manufacturer. Connect the fan cable to the connector while matching the black wire to pin#1.

JCFAN1: CPU Fan Header

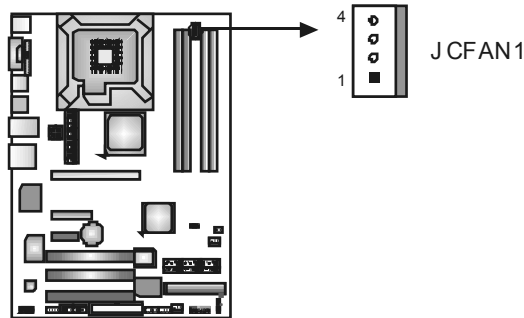

Pin	Assignment
1	Ground
2	+12V
3	FAN RPM rate sense
4	Smart Fan Control

JSFAN1: System Fan Header

JNFAN1: Northbridge Fan Header

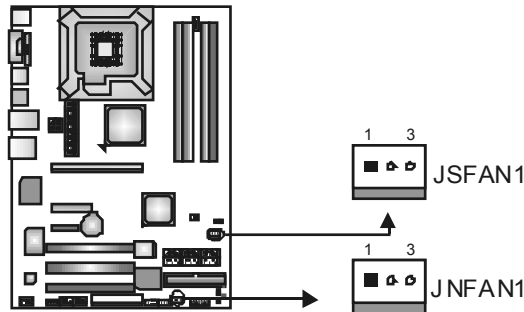

Pin	Assignment
1	Ground
2	+12V
3	FAN RPM rate sense

Note:

The JNFAN1 and JSFAN1 support 3-pin head connector. When connecting with wires onto connectors, please note that the red wire is the positive and should be connected to pin#2, and the black wire is Ground and should be connected to GND.

2.3 INSTALLING SYSTEM MEMORY

A. Memory Modules

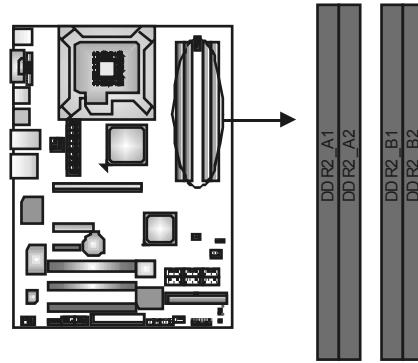

1. Unlock a DIMM slot by pressing the retaining clips outward. Align a DIMM on the slot such that the notch on the DIMM matches the break on the Slot.

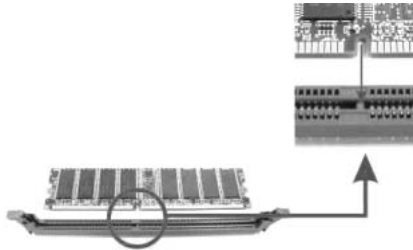

2. Insert the DIMM vertically and firmly into the slot until the retaining chip snap back in place and the DIMM is properly seated.

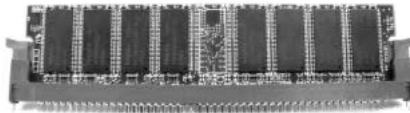

B. Memory Capacity

DIMM Socket Location	DDR Module	Total Memory Size
DDR2_A1	256MB/512MB/1GB/2GB	Max is 8GB.
DDR2_A2	256MB/512MB/1GB/2GB	
DDR2_B1	256MB/512MB/1GB/2GB	
DDR2_B2	256MB/512MB/1GB/2GB	

B. Dual Channel Memory installation

To trigger the Dual Channel function of the motherboard, the memory module must meet the following requirements:

Install memory module of the same density in pairs, shown in the following table.

Dual Channel Status	DDR2_A1	DDR2_A2	DDR2_B1	DDR2_B2
Enabled	O	X	O	X
Enabled	X	O	X	O
Enabled	O	O	O	O

(O means memory installed, X means memory not installed.)

The DRAM bus width of the memory module must be the same (x8 or x16)

2.4 CONNECTORS AND SLOTS

FDD1: Floppy Disk Connector

The motherboard provides a standard floppy disk connector that supports 360K, 720K, 1.2M, 1.44M and 2.88M floppy disk types. This connector supports the provided floppy drive ribbon cables.

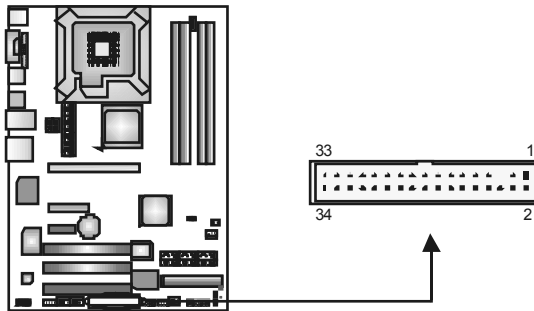

IDE1: Hard Disk Connector

The motherboard has a 32-bit Enhanced PCI IDE Controller that provides PIO Mode 0~4, Bus Master, and Ultra DMA 33/66/100/133 functionality.

The IDE connector can connect a master and a slave drive, so you can connect up to two hard disk drives.

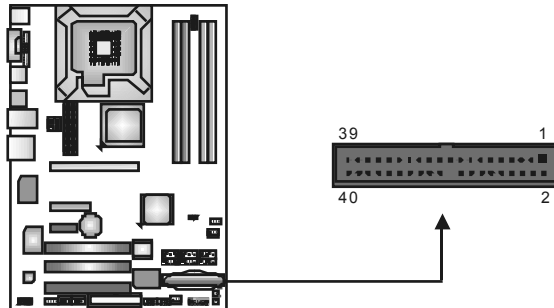

PCI-Ex16: PCI-Express x16 Slot

- PCI-Express 1.0a compliant.
- Maximum theoretical realized bandwidth of 4GB/s simultaneously per direction, for an aggregate of 8GB/s totally.

PCI-EX4: PCI-Express x4 Slot

- PCI-Express 1.0a compliant.
- Maximum theoretical realized bandwidth of 1GB/s simultaneously per direction, for an aggregate of 2GB/s totally.

PCI-EX1: PCI-Express Slot

- PCI-Express 1.0a compliant.

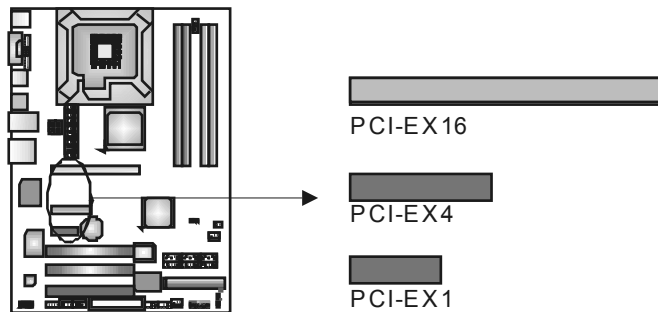

PCI1~PCI3: Peripheral Component Interconnect Slots

This motherboard is equipped with 3 standard PCI slots. PCI stands for Peripheral Component Interconnect, and it is a bus standard for expansion cards. This PCI slot is designated as 32 bits.

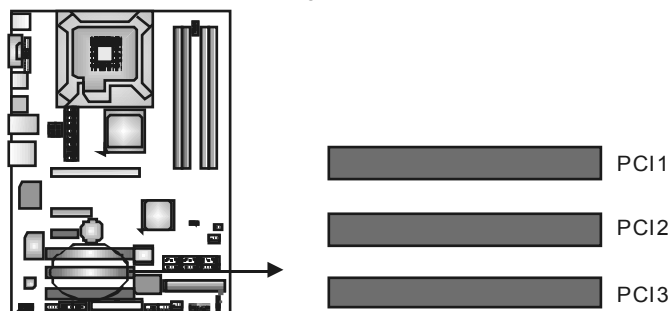

CHAPTER 3: HEADERS & JUMPERS SETUP

3.1 HOW TO SETUP JUMPERS

The illustration shows how to set up jumpers. When the jumper cap is placed on pins, the jumper is “close”, if not, that means the jumper is “open”.



3.2 DETAIL SETTINGS

JPANEL1: Front Panel Header

This 24-pin connector includes Power-on, Reset, HDD LED, Power LED, Sleep button and speaker connection. It allows user to connect the PC case’s front panel switch functions.

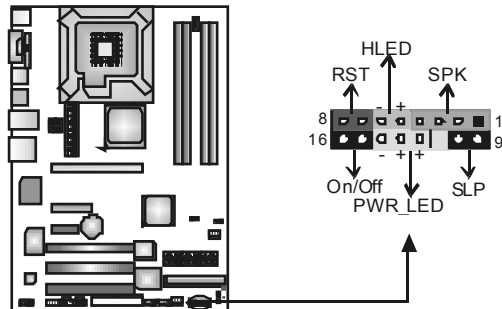

Pin	Assignment	Function	Pin	Assignment	Function
1	+5V	Speaker Connector	9	Sleep control	Sleep button
2	N/A		10	Ground	
3	N/A		11	N/A	N/A
4	Speaker	Hard drive LED	12	Power LED (+)	Power LED
5	HDD LED (+)		13	Power LED (+)	
6	HDD LED (-)	Reset button	14	Power LED (-)	Power-on button
7	Ground		15	Power button	
8	Reset control		16	Ground	

ATX Power Source Connector: JATXPWR2

JATXPWR2 allows user to connect 24-pin power connector on the ATX power supply.

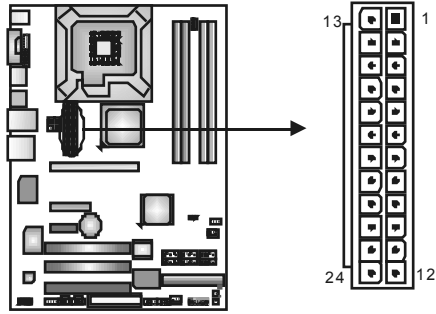

Pin	Assignment	Pin	Assignment
13	+3.3V	1	+3.3V
14	-12V	2	+3.3V
15	Ground	3	Ground
16	PS_ON	4	+5V
17	Ground	5	Ground
18	Ground	6	+5V
19	Ground	7	Ground
20	NC	8	PW_OK
21	+5V	9	Standby Voltage+5V
22	+5V	10	+12V
23	+5V	11	+12V
24	Ground	12	+3.3V

JATXPWR1: ATX Power Source Connector

By connecting this connector, it will provide +12V to CPU power circuit.

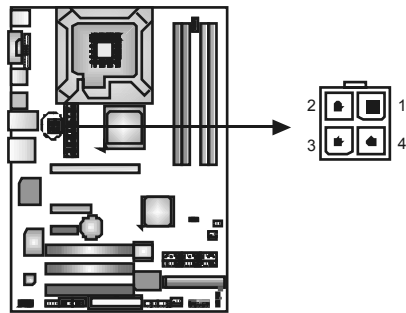

Pin	Assignment
1	+12V
2	+12V
3	Ground
4	Ground

JUSB3/JUSB4: Headers for USB 2.0 Ports at Front Panel

This header allows user to connect additional USB cable on the PC front panel, and also can be connected with internal USB devices, like USB card reader.

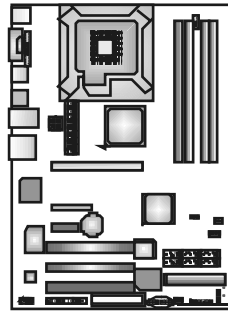

JUSB4 JUSB3



Pin	Assignment
1	+5V (fused)
2	+5V (fused)
3	USB-
4	USB-
5	USB+
6	USB+
7	Ground
8	Ground
9	Key
10	NC

JAUDIO F1: Front Panel Audio Header

This header allows user to connect the front audio output cable with the PC front panel. It will disable the output on back panel audio connectors.

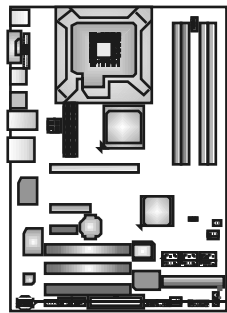

Pin	Assignment
1	Mic in/center
2	Ground
3	Mic power/Bass
4	Audio power
5	Right line out/ Speaker out Right
6	Right line out/ Speaker out Right
7	Reserved
8	Key
9	Left line out/ Speaker out Left
10	Left line out/ Speaker out Left

JCDIN1: CD-ROM Audio-in Connector

This connector allows user to connect the audio source from the variety devices, like CD-ROM, DVD-ROM, PCI sound card, PCI TV turner card etc..

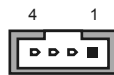
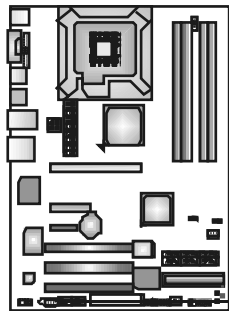

Pin	Assignment
1	Left Channel Input
2	Ground
3	Ground
4	Right Channel Input

JCMOS1: Clear CMOS Header

By placing the jumper on pin2-3, it allows user to restore the BIOS safe setting and the CMOS data, please carefully follow the procedures to avoid damaging the motherboard.

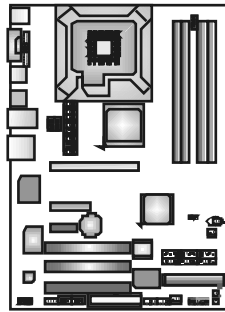

Pin 1-2 Close:
Normal Operation (default).



Pin 2-3 Close:
Clear CMOS data.

※ Clear CMOS Procedures:

1. Remove AC power line.
2. Set the jumper to "Pin 2-3 close".
3. Wait for five seconds.
4. Set the jumper to "Pin 1-2 close".
5. Power on the AC.
6. Reset your desired password or clear the CMOS data.

SATA1~SATA6: Serial ATA Connectors

The motherboard has a PCI to SATA Controller with 4 or 6 channels SATA interface, it satisfies the SATA 2.0 spec and with transfer rate of 3.0Gb/s.

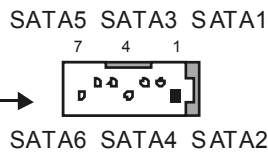
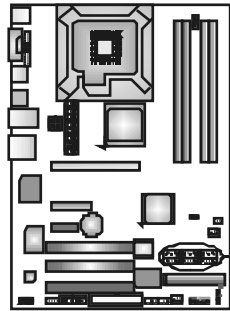

Pin	Assignment
1	Ground
2	TX+
3	TX-
4	Ground
5	RX-
6	RX+
7	Ground

JSPDIF_OUT1: Digital Audio-out Connector

This connector allows user to connect the PCI bracket SPDIF output header.

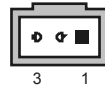
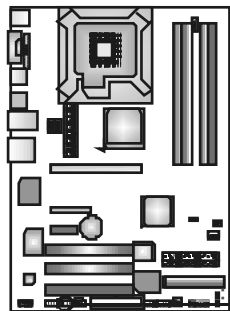

Pin	Assignment
1	+5V
2	SPDIF_OUT
3	Ground

JSPDIF_IN1: Digital Audio-in Connector

This connector allows user to connect the PCI bracket SPDIF input header.

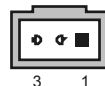
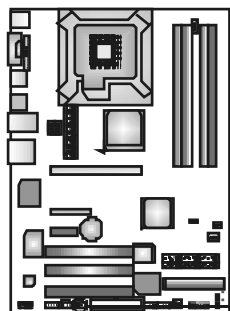

Pin	Assignment
1	+5V
2	SPDIF_IN
3	Ground

Header for Memory Over-voltage: JDDRII_2.2V

When processing Memory over-voltage, please place the jumper to pin 2-3 Closed. The Default setting is Pin 1-2 Closed.

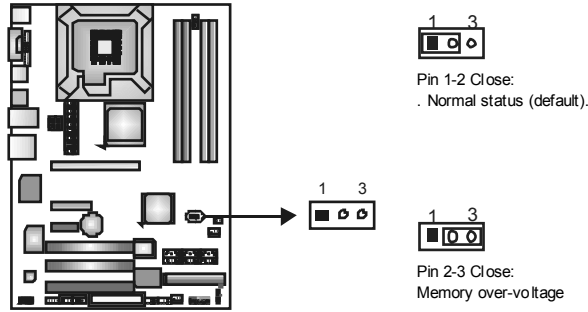

Note:

1. When “JDDRII_2.2V” jumper cap is placed on Pin 1-2, memory voltage can be manually adjusted under CMOS setup.
2. When “JDDRII_2.2V” jumper cap is placed on Pin 2-3, memory voltage will be fixed at 2.2V automatically, and can't be adjusted under COMS setup.

Before setting memory over-voltage, please ensure that your DDR supports up to 2.2V. (Consulting your DDR supplier)

On-Board LED Indicators

There are 2 LED indicators on the motherboard to show system status.

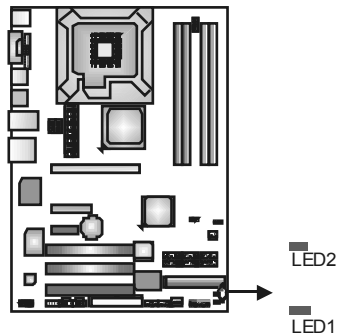

LED1 and LED2:

These 2 LED indicate system power on diagnostics. Please refer to the table below for different messages:

LED1	LED2	Message
ON	ON	Normal
ON	OFF	VGA Error
OFF	ON	Memory Error
OFF	OFF	Abnormal: CPU / Chipset error

On-Board Buttons

There are 2 on-board buttons.

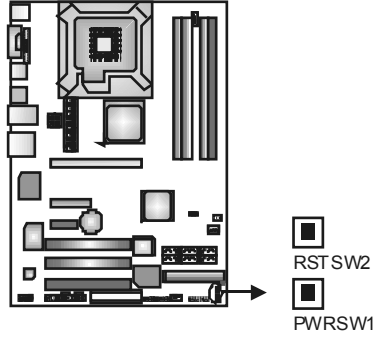

PWRSW1:

This is an on-board Power Switch button.

RSTSW2:

This is an on-board Reset button.

JPRNT1: Printer Port Connector

This header allows you to connector printer on the PC.

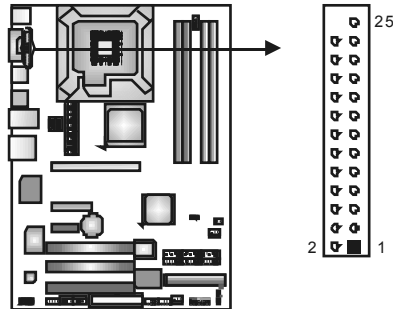

Pin	Assignment	Pin	Assignment
1	-Strobe	14	Ground
2	-ALF	15	Data 6
3	Data 0	16	Ground
4	-Error	17	Data 7
5	Data 1	18	Ground
6	-Init	19	-ACK
7	Data 2	20	Ground
8	-Scltin	21	Busy
9	Data 3	22	Ground
10	Ground	23	PE
11	Data 4	24	Ground
12	Ground	25	SCLT
13	Data 5		

CHAPTER 4: INTEL RAID FUNCTIONS (FOR TFORCE P965 DELUXE)

4.1 OPERATION SYSTEM

Supports Windows XP Home/Professional Edition, and Windows 2000 Professional.

4.2 RAID ARRAYS

ICH8R supports the following types of RAID arrays:

RAID 0: RAID 0 defines a disk striping scheme that improves disk read and write times for many applications.

RAID 1: RAID 1 defines techniques for mirroring data.

Spanning (JBOD): JBOD provides a method for combining drives of different sizes in to one large disk.

RAID 5: RAID 5 provides fault tolerance and better utilization of disk capacity.

RAID 1+0: RAID 1+0 combines the techniques used in RAID 0 and RAID 1.

4.3 How RAID WORKS

RAID 0:

The controller “stripes” data across multiple drives in a RAID 0 array system. It breaks up a large file into smaller blocks and performs disk reads and writes across multiple drives in parallel. The size of each block is determined by the stripe size parameter, which you set during the creation of the RAID set based on the system environment. This technique reduces overall disk access time and offers high bandwidth.

Features and Benefits

- **Drives:** Minimum 1, and maximum is up to 6 or 8. Depending on the platform.
- **Uses:** Intended for non-critical data requiring high data throughput, or any environment that does not require fault tolerance.
- **Benefits:** provides increased data throughput, especially for large files. No capacity loss penalty for parity.
- **Drawbacks:** Does not deliver any fault tolerance. If any drive in the array fails, all data is lost.
- **Fault Tolerance:** No.

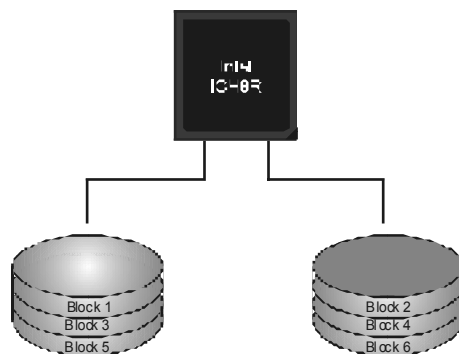

RAID 1:

Every read and write is actually carried out in parallel across 2 disk drives in a RAID 1 array system. The mirrored (backup) copy of the data can reside on the same disk or on a second redundant drive in the array. RAID 1 provides a hot-standby copy of data if the active volume or drive is corrupted or becomes unavailable because of a hardware failure.

RAID techniques can be applied for high-availability solutions, or as a form of automatic backup that eliminates tedious manual backups to more expensive and less reliable media.

Features and Benefits

- **Drives:** Minimum 2, and maximum is 2.
- **Uses:** RAID 1 is ideal for small databases or any other application that requires fault tolerance and minimal capacity.
- **Benefits:** Provides 100% data redundancy. Should one drive fail, the controller switches to the other drive.
- **Drawbacks:** Requires 2 drives for the storage space of one drive. Performance is impaired during drive rebuilds.
- **Fault Tolerance:** Yes.

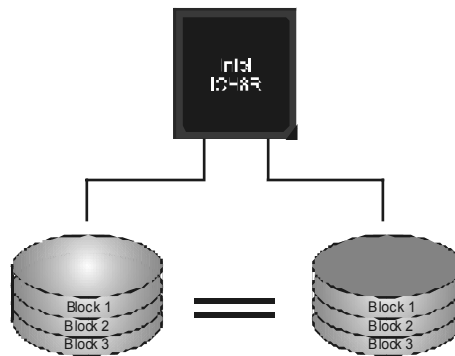

Spanning (JBOD):

JBOD stands for “Just a Bunch of Disks”. Each drive is accessed as if it were on a standard SCSI host bus adapter. This is useful when a single drive configuration is needed, but it offers no speed improvement or fault tolerance.

Features and Benefits

- **Uses:** JBOD works best if you have odd sized drives and you want to combine them to make one big drive.
- **Benefits:** JBOD provides the ability to combine odd size drives using all of the capacity of the drives.
- **Drawbacks:** Decreases performance because of the difficulty in using drives concurrently.
- **Fault Tolerance:** Yes.

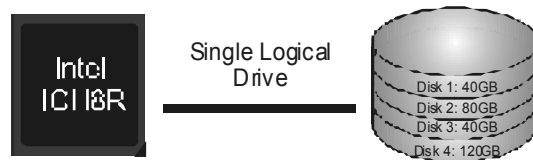

RAID 5:

RAID 5 stripes both data and parity information across three or more drives. It writes data and parity blocks across all the drives in the array. Fault tolerance is maintained by ensuring that the parity information for any given block of data is placed on a different drive from those used to store the data itself.

Features and Benefits

- **Drives: Minimum 3.**
- **Uses: RAID 5 is recommended for transaction processing and general purpose service.**
- **Benefits: An ideal combination of good performance, good fault tolerance, and high capacity and storage efficiency.**
- **Drawbacks: Individual block data transfer rate same as a single disk. Write performance can be CPU intensive.**
- **Fault Tolerance: Yes.**

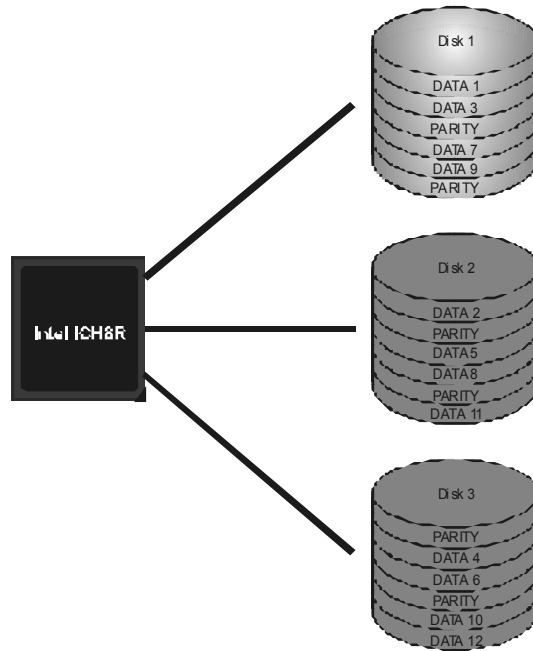

RAID 1+0:

RAID 1 drives can be striped using RAID 0 techniques. Resulting in a RAID 1+0 solution for improved resiliency, performance and rebuild performance.

Features and Benefits

- **Drives:** Minimum 4, and maximum is 6 or 8, depending on the platform.
- **Benefits:** Optimizes for both fault tolerance and performance, allowing for automatic redundancy. May be simultaneously used with other RAID levels in an array, and allows for spare disks.
- **Drawbacks:** Requires twice the available disk space for data redundancy, the same as RAID level 1.
- **Fault Tolerance:** Yes.

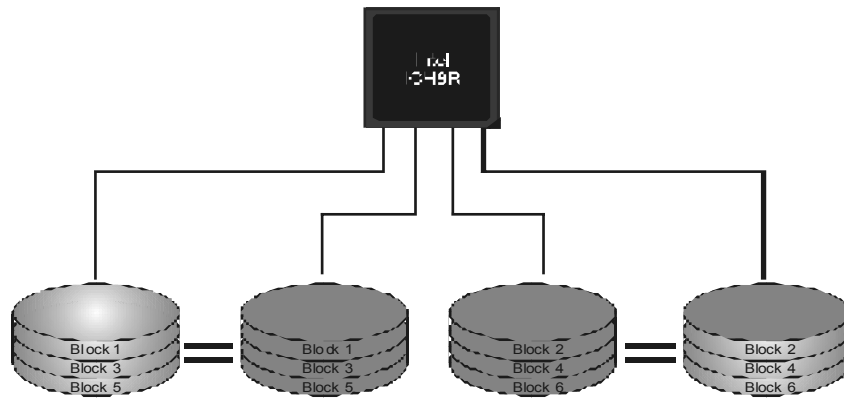

※ For more detailed setup information, please refer to the Driver CD

CHAPTER 5: OVERCLOCK QUICK GUIDE

5.1 T-POWER INTRODUCTION

Biostar T-Power is a whole new utility that is designed for overclock users. Based on many precise tests, *Biostar Engineering Team* (BET) has developed this ultimate overclock engine to raise system performance. No matter whether under BIOS or Windows interface, *T-Power* is able to present the best system state according to users' overclock setting.

T-Power BIOS Features:

- Overclocking Navigator Engine (O.N.E.)
- CMOS Reloading Program (C.R.P.)
- Memory Integration Test (M.I.T., under Overclock Navigator Engine)
- Integrated Flash Program (I.F.P.)
- Smart Fan Function (under PC Health Status)
- Self Recovery System (S.R.S)

T-Power Windows Feature:

- Hardware Monitor
- Overclock Engine
- Smart Fan Function
- Life Update

5.2 T-POWER BIOS FEATURE

A. Overclocking Navigator Engine (O.N.E.):

ONE provides two powerful overclocking engines: MOS and AOS for both Elite and Casual overclockers.

```

Phoenix - Award WorkstationBIOS CMOS Setup Utility
OverClock Navigator Engine

----- Automate Overclock System -----
x Auto Overclock System      U6 -Tech Engine
----- Manual Overclock System -----
** CPU Spec Voltage **      1.500U
** NB/SB Spec Voltage **    1.52U
** Memory Spec Voltage **   2.60U
x CPU Voltage                StartUp
x NB/SB Voltage Regulator    1.52U
x Memory Voltage            2.60U

x CPU Frequency              200
x Hammer CPU Multiplier     StartUp
x HT Frequency               Auto
x PCIe Clock                 100MHz
x Memclock Frequency        200MHz
x 1T/2T Memory Timing       2T
x DRAM Configuration        Press Enter
Integrated Memory Test      [Disabled]

Item Help
Menu Level  ▶

↑↓:Move Enter:Select +/-PU/PD:Value F10:Save ESC:Exit F1:General Help
F5:Previous Values F7: Optimized Defaults
    
```

Manual Overclock System (M.O.S.)

MOS is designed for experienced overclock users.

It allows users to customize personal overclock settings.

```

Phoenix - Award WorkstationBIOS CMOS Setup Utility
OverClock Navigator Engine

----- Automate Overclock System -----
x Auto Overclock System      U6 -Tech Engine
----- Manual Overclock System -----
** CPU Spec Voltage **      1.500U
** NB/SB Spec Voltage **    1.52U
** Memory Spec Voltage **   2.60U
x CPU Voltage                StartUp
x NB/SB Voltage Regulator    1.52U
x Memory Voltage            2.60U

x CPU Frequency              200
x Hammer CPU Multiplier     StartUp
x HT Frequency               Auto
x PCIe Clock                 100MHz
x Memclock Frequency        200MHz
x 1T/2T Memory Timing       2T
x DRAM Configuration        Press Enter
Integrated Memory Test      [Disabled]

Item Help
Menu Level  ▶

----- Overclock Navigator -----
Normal          ..... [ # ]
Automate Overclock ..... [ ]
Manual Overclock ..... [ ]

↑↓:Move ENTER:Accept ESC:Abort

↑↓:Move Enter:Select +/-PU/PD:Value F10:Save ESC:Exit F1:General Help
F5:Previous Values F7: Optimized Defaults
    
```

```

Phoenix - Award WorkstationBIOS CMOS Setup Utility
OverClock Navigator Engine

----- Automate Overclock System -----
x Auto Overclock System      U6 -Tech Engine
----- Manual Overclock System -----
** CPU Spec Voltage **      1.500U
** NB/SB Spec Voltage **    1.52U
** Memory Spec Voltage **   2.60U
CPU Voltage                [StartUp]
NB/SB Voltage Regulator    [1.52U]
Memory Voltage            [2.60U]

CPU Frequency              [200]
Hammer CPU Multiplier     [StartUp]
HT Frequency               [Auto]
PCIe Clock                 [100MHz]
Memclock Frequency        [200MHz]
1T/2T Memory Timing       [2T]
▶ DRAM Configuration      [Press Enter]
Integrated Memory Test    [Disabled]

Item Help
Menu Level  ▶

↑↓:Move Enter:Select +/-PU/PD:Value F10:Save ESC:Exit F1:General Help
F5:Previous Values F7: Optimized Defaults
    
```

CPU Overclock Setting:

CPU Voltage:

This function will increase CPU stability when overclocking. However, the CPU temperature will increase when CPU voltage is increased.

Choices: The range is from 1.2V to 1.725V, with an interval of 0.025V.

CPU Frequency:

CPU Frequency is directly in proportion to system performance. To maintain the system stability, CPU voltage needs to be increased also when raising CPU frequency.

Choices: This range is from 200 to 450, with an interval of 1MHz.

Memory Overclock Setting:

Memory Voltage:

This function will increase memory stability when overclocking.

Choices: The range is from 1.85V to 2.0V, with an interval of 0.05V.

Memclock Frequency:

To get better system performance, sometimes downgrading the memory frequency is necessary when CPU frequency is adjusted over the upper limit.

Choices: DDR2 400, DDR2 533, DDR2 667, DDR2 800 (MHz).

PCI-Express Overclock Setting:

PCI-E Clock:

It helps to increase VGA card performance.

Choices: The range is from 100 to 145, with an interval of 1MHz.

Chipset Overclock Setting:

NB/SB Voltage Regulator:

This function will increase chipset stability when overclocking.

Choices: 1.52V, 1.60V, 1.68V, 1.76V.

HT Frequency:

We recommend users to set this item at "x4" when overclocking.

Choices: x1, x2, x3, x4, x5, Auto.

Motherboard Manual

Automatic Overclock System (A.O.S.)

For beginners in overclock field, BET had developed an easy, fast, and powerful feature to increase the system performance, named A.O.S. Based on many tests and experiments, A.O.S. provides 3 ideal overclock configurations that are able to raise the system performance in a single step.



V6 Tech Engine:

This setting will raise about 10%~15% of whole system performance.



V8 Tech Engine:

This setting will raise about 15%~25% of whole system performance.



V12 Tech Engine:

This setting will raise about 25%~30% of whole system performance.



B. CMOS Reloading Program (C.R.P.):

It allows users to save different CMOS settings into BIOS-ROM.

Users are able to reload any saved CMOS setting for customizing system configurations.

Moreover, users are able to save an ideal overclock setting during overclock operation.

There are 50 sets of record addresses in total, and users are able to name the CMOS data according to personal preference.

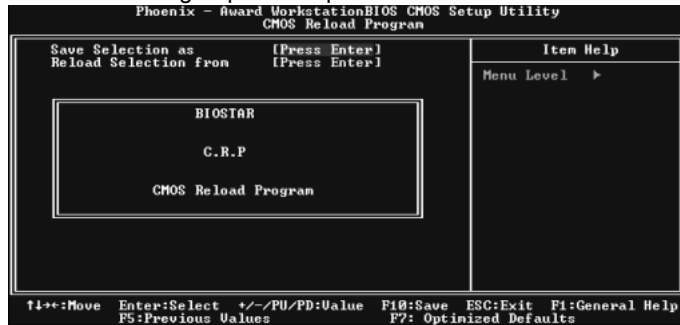

C. Memory Integration Test (M.I.T.):

This function is under “Overclock Navigator Engine” item. MIT allows users to test memory compatibilities, and no extra devices or software are needed.

Step 1:

The default setting under this item is “Disabled”, the condition parameter should be changed to “Enable” to proceed this test.

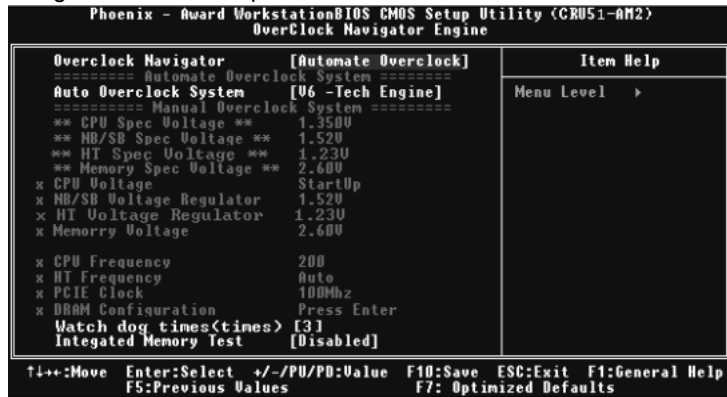

Step 2:

Save and Exit from CMOS setup and reboot the system to activate this test. Run this test for 5 minutes (minimum) to ensure the memory stability.

Step 3:

When the process is done, change the setting back from “Enable” to “Disable” to complete the test.

D. Self Recovery System (S.R.S.):

This function can't be seen under T-Power BIOS setup; and is always on whenever the system starts up.

However, it can prevent system hang-up due to inappropriate overclock actions.

When the system hangs up, S.R.S. will automatically log in the default BIOS setting, and all overclock settings will be re-configured.

E. Integrated Flash Program (I.F.P.):

IFP is a safe and quick way to upgrade BIOS.

Step 1:

Go to Biostar website (<http://www.biostar.com.tw>) to download the latest BIOS file. Then, save the file into a floppy disk.

Step 2:

Insert the floppy disk and reboot the system to get into CMOS screen.

Step 3:

Select the item "Integrated Flash Program" to get the following frame and choose the BIOS file downloaded in step 1.



Step 4:

Press "Enter" key to start BIOS file loading, and BIOS updating will process automatically.

Step 5:

When the BIOS update is completed, press YES to the message "Flash done, Reset system", and the system will reboot automatically to finish the process.

Advise:

You can update the system BIOS by simply pressing "Enter" key for three times.

F. Smart Fan Function:

Smart Fan Function is under “PC Health Status”. This is a brilliant feature to control CPU Temperature vs. Fan speed. When enabling Smart Fan function, Fan speed is controlled automatically by CPU temperature. This function will protect CPU from overheat problem and maintain the system temperature at a safe level.



CPU Fan Off <°C>:

If the CPU temperature is lower than the set value, the CPU fan will turn off. The range is from 0°C ~127°C, with an interval of 1°C. Choices: 16°C (default).

CPU Fan Start <°C >

The CPU fan starts to work when CPU temperature arrives to this set value. The range is from 0°C ~127°C, with an interval of 1°C. Choices: 32°C (default).

CPU Fan Full speed <°C >

When CPU temperature arrives to the set value, the CPU fan will work under Full Speed. The range is from 0°C ~127°C, with an interval of 1°C. Choices: 52°C (default).

Start PWM Value

When CPU temperature arrives to the set value, the CPU fan will work under Smart Fan Function mode. The range is from 0~127, with an interval of 1.

Choices: 32 (default).

Slope PWM

Choices: 1 PWM Value/°C (default), 2 PWM Value/°C, 4 PWM Value/°C, 8 PWM Value/°C, 16 PWM Value/°C, 32 PWM Value/°C, 64 PWM Value/°C.

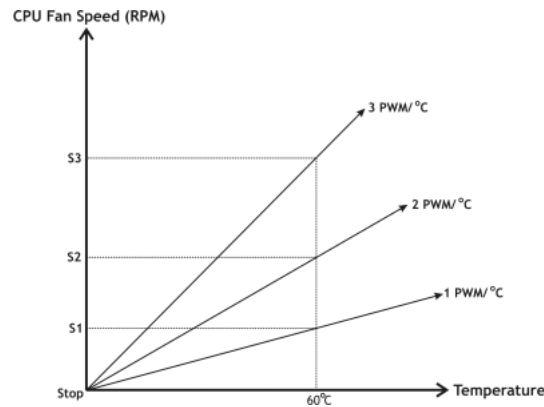

S1: CPU temperature is 60°C, and PWM value is 1 PWM/°C.

S2: CPU temperature is 60°C, and PWM value is 2 PWM/°C.

S3: CPU temperature is 60°C, and PWM value is 3 PWM/°C.

Increasing the value of slope PWM will raise the speed of CPU fan.

As in above diagram, when the CPU temperature reaches 60°C, the CPU fan speed for 3 PWM/°C is higher than 1 PWM/°C (S1<S2<S3).

5.3 T-POWER WINDOWS FEATURE

A. Hardware Monitor:

T-Power Hardware monitor allows users to monitor system voltage, temperature and fan speed accordingly. Additionally, a rescue action will be taken by the program automatically while the system faces an abnormal condition. The program will trigger an alarm or shut down the system when unpredictable errors occur. All the monitoring items are illustrated by a waveform diagram.

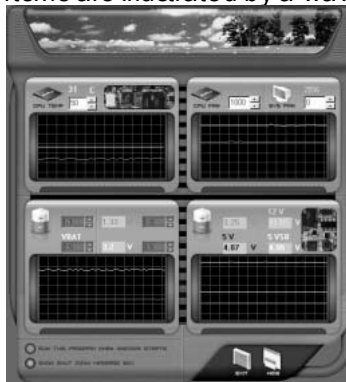

Hardware Monitor Toolbar



i. Start-up Setting

Click on this item to run Hardware Monitor Program when the Windows starts-up.

ii. Dialogue-Box Setting

Click on this item to pop-up warning dialogue-box when PC system is abnormal.

iii. Exit

Click on this item to exit Hardware Monitor Program.

iv. Hide

Click on this item to hide this program in system tray. When hiding the program, there will be a check icon in the system tray.



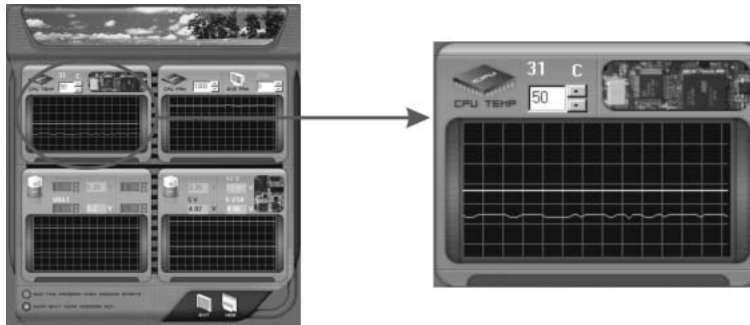

CPU Temperature

This column configures the CPU temperature. There is a waveform to represent the status of CPU temperature.



By adjusting , users can easily configure the upper limit of CPU temperature for system operating.

In this diagram, the white line represents the upper limit which user-set for CPU temperature and the green line shows present CPU temperature.

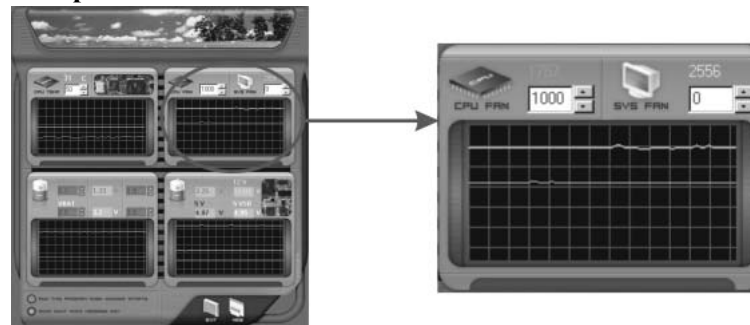

If the CPU temperature is higher than the upper limit, the status line color will change from green to red, and a warning sound will alert you. Also, the system tray icon  would change to .

FAN Speed



By adjusting , users can easily configure the lower limit of the fan speed.

In this diagram, the green line shows present CPU Fan speed, and the yellow line shows System Fan speed (if any).

If any one of the fans speeds is lower than the set value, the status line will change into a red warning line, and the program will trigger an alarm system automatically. Also, the system tray icon  would change to .

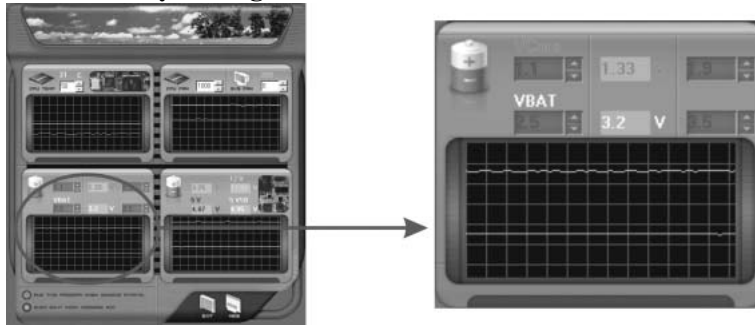

CPU/Battery Voltage



i. VCore

This item displays the CPU voltage, represented by a light blue line.



Users can set the upper and lower limit by adjusting  to monitor the CPU operating voltage.

If CPU voltage is higher or lower than the set value, the status line will change into a red warning line, and a warning sound will alert you. Also, the system tray icon  will change to .

ii. VBAT

This item displays the CMOS battery voltage, represented by a light green line.

Users can set the upper and lower limit by adjusting  to monitor the status of battery voltage.

If battery voltage is higher or lower than the set value, the status line will change to a red warning line, and a warning sound will alert you. Also, the system tray icon  will change to .

Reference data

This column represents the status of power supply voltage and cannot be adjusted, it is only for present status reference.

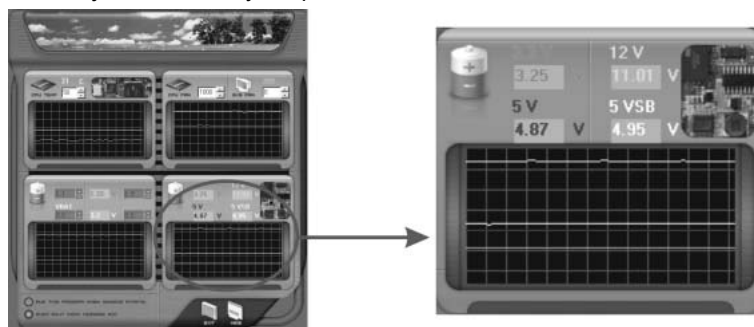

B. Overclocking Configurations

This diagram is designed for T-series Overclocking utility. Friendly interface and solid overclock features are the major concept of this utility.

Graphic 1 will appear when activating this utility.



Graphic 1

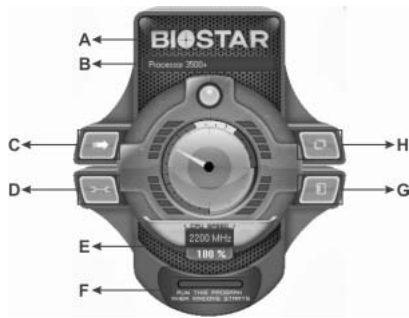

Graphic 2

- A. Clicking on “Biostar” will lead you to the Biostar Homepage.
- B. This column shows the CPU speed information.
- C. Click on this button and the utility will pop-up 4 sub-screens (Please refer to Graphic 3).
- D. Click on this button to minimize this program to taskbar.
- E. This column shows present CPU speed and overclocking percentage.
- F. Clicking on this button will make the program start up as soon as the Windows starts up.
- G. Click on this button to exit this overclock utility.
- H. Click on this button to reset all the overclock features to default setting.

By adjusting the overclocking features in 4 sub-screens, users can tune the system performance to an optimal level.

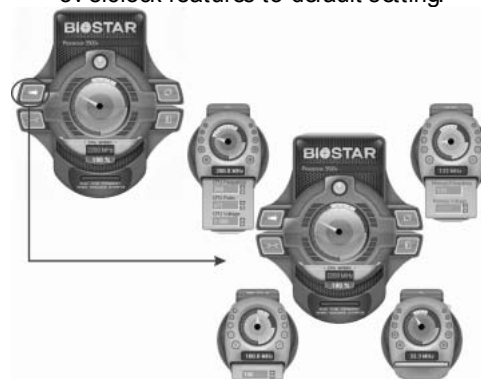

Graphic 3

CPU Overclocking Settings:



By adjusting  can configure three items for CPU overclocking.

- A. CPU Frequency**
Range: 200MHz~450MHz.
Interval: 1MHz.
- B. CPU Ratio**
Range: 4~ 25.
Interval: 1.
- C. CPU Voltage**
Range: 0.8V~ 2.0V.
Interval: 0.0125V.

Memory Overclocking Settings:



By adjusting  can configure two items for Memory overclocking.

- A. Memory Clock Frequency**
Choices: 100, 133, 200, 266, 333, 400, 533, 667, 800.
- B. Memory Voltage**
Range: 1.8V~ 2.8V.
Interval: 0.1V.

AGP/PCI-Express Overclocking Setting:



By adjusting  can configure VGA card overclocking. And this function helps to increase VGA card performance.

Range: 100MHz~150MHz.
Interval: 1MHz.

PCI Overclocking Setting:



This diagram shows present PCI working status and helps to monitor PCI peripherals working status.

This item cannot be adjusted.

C. Smart Fan Function

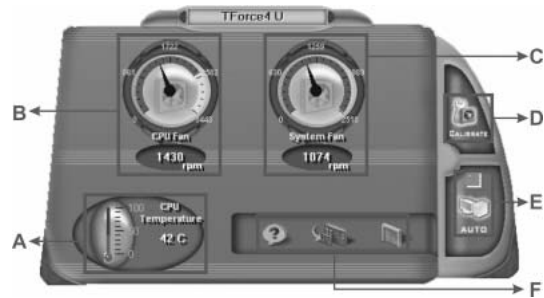

When Smart Fan Function is activated, screens will pop-up to illustrate the fan speed information.

i. CPU Temperature:

Show current CPU temperature.

ii. CPU Fan speed:

Show current CPU Fan speed.

iii. System Fan speed:

Show current system Fan speed.

iv. Calibrate:

When changing CPU Fan or System Fan, click on this button to re-calibrate the Fan speed.

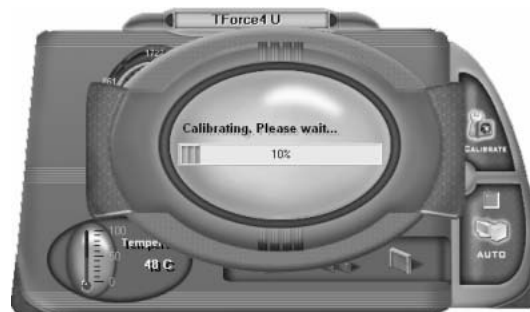

Note:

1. When Smart Fan Function activates for the first time, this calibrate function would auto-run to get upper and lower limitation of CPU Fan and System Fan.
2. When calibrating process is done, the calibrating window will auto-close, and the main screen will show new fan speed data.

v. Auto:



If the green indicator is lit up, the Smart Fan Function is “On” (Default Setting).

Click on this button again to close Smart Fan Function, and a screen as below would pop-up.

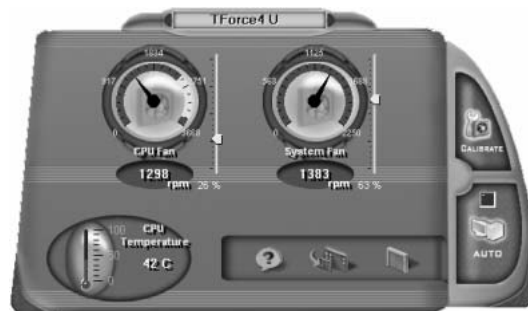
There will be pulling-meter besides the CPU Fan and System Fan, the CPU Fan and the System Fan speed can be adjusted by adjusting the Cursor Up or Down.



vi. Program Tool Bar:

-  **About:**
Click on this button to get program-related information.
-  **Minimize:**
Click on this button to minimize the program to system tray
-  **Exit:**
Click on this button to exit this program.

D. Live Update



When Live Update program is activated, a screen will pop up to illustrate BIOS related information.

i. Link to Internet:

Click on this button will link to Biostar website and BIOS file will be downloaded.

ii. Update BIOS:

Click on this button to run BIOS flashing process, and it's easy and safe.

iii. Backup BIOS:

Click on this button, and BIOS file will be saved into the user-selected folder.

iv. Clear CMOS:

Click on this item will clear the CMOS Data. When carrying this job, the previous CMOS data would be cleared and returned to default setting.

CHAPTER 6: USEFUL HELP

6.1 DRIVER INSTALLATION NOTE

After you installed your operating system, please insert the Fully Setup Driver CD into your optical drive and install the driver for better system performance.

You will see the following window after you insert the CD



The setup guide will auto detect your motherboard and operating system.

Note:

If this window didn't show up after you insert the Driver CD, please use file browser to locate and execute the file **SETUP.EXE** under your optical drive.

A. Driver Installation

To install the driver, please click on the Driver icon. The setup guide will list the compatible driver for your motherboard and operating system. Click on each device driver to launch the installation program.

B. Software Installation

To install the software, please click on the Software icon. The setup guide will list the software available for your system, click on each software title to launch the installation program.

C. Manual

Aside from the paperback manual, we also provide manual in the Driver CD. Click on the Manual icon to browse for available manual.

Note:

You will need Acrobat Reader to open the manual file. Please download the latest version of Acrobat Reader software from <http://www.adobe.com/products/acrobat/readstep2.html>

6.2 AWARD BIOS BEEP CODE

Beep Sound	Meaning
One long beep followed by two short beeps	Video card not found or video card memory bad
High-low siren sound	CPU overheated System will shut down automatically
One Short beep when system boot-up	No error found during POST
Long beeps every other second	No DRAM detected or install

6.3 EXTRA INFORMATION

A. BIOS Update

After you fail to update BIOS or BIOS is invaded by virus, the Boot-Block function will help to restore BIOS. If the following message is shown after boot-up the system, it means the BIOS contents are corrupted.

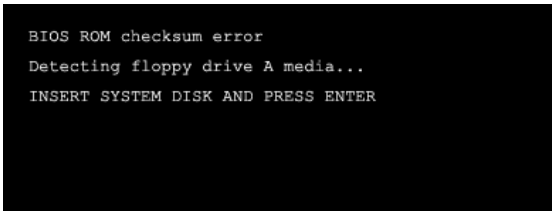

```
BIOS ROM checksum error
Detecting floppy drive A media...
INSERT SYSTEM DISK AND PRESS ENTER
```

In this Case, please follow the procedure below to restore the BIOS:

1. Make a bootable floppy disk.
2. Download the Flash Utility "AWDFLASH.exe" from the Biostar website: www.biostar.com.tw
3. Confirm motherboard model and download the respectively BIOS from Biostar website.
4. Copy "AWDFLASH.exe" and respectively BIOS into floppy disk.
5. Insert the bootable disk into floppy drive and press Enter.
6. System will boot-up to DOS prompt.
7. Type "*Awdflash xxxx.bf/sn/py/r*" in DOS prompt.
(xxxx means BIOS name.)
8. System will update BIOS automatically and restart.
9. The BIOS has been recovered and will work properly.

B. CPU Overheated

If the system shutdown automatically after power on system for seconds, that means the CPU protection function has been activated.

When the CPU is over heated, the motherboard will shutdown automatically to avoid a damage of the CPU, and the system may not power on again.

In this case, please double check:

1. The CPU cooler surface is placed evenly with the CPU surface.
2. CPU fan is rotated normally.
3. CPU fan speed is fulfilling with the CPU speed.

After confirmed, please follow steps below to relief the CPU protection function.

1. Remove the power cord from power supply for seconds.
2. Wait for seconds.
3. Plug in the power cord and boot up the system.

Or you can:

1. Clear the CMOS data.
(See "Close CMOS Header: JCMOS1" section)
2. Wait for seconds.
3. Power on the system again.

6.4 TROUBLESHOOTING

Probable	Solution
<ol style="list-style-type: none"> 1. No power to the system at all. Power light don't illuminate, fan inside power supply does not turn on. 2. Indicator light on key board does not turn on. 	<ol style="list-style-type: none"> 1. Make sure power cable is securely plugged in. 2. Replace cable. 3. Contact technical support.
<p>System inoperative. Keyboard lights are on, power indicator lights are lit, and hard drive is spinning.</p>	<p>Using even pressure on both ends of the DIMM, press down firmly until the module snaps into place.</p>
<p>System does not boot from hard disk drive, can be booted from optical drive.</p>	<ol style="list-style-type: none"> 1. Check cable running from disk to disk controller board. Make sure both ends are securely plugged in; check the drive type in the standard CMOS setup. 2. Backing up the hard drive is extremely important. All hard disks are capable of breaking down at any time.
<p>System only boots from optical drive. Hard disk can be read and applications can be used but booting from hard disk is impossible.</p>	<ol style="list-style-type: none"> 1. Back up data and applications files. 2. Reformat the hard drive. Re-install applications and data using backup disks.
<p>Screen message says "Invalid Configuration" or "CMOS Failure."</p>	<p>Review system's equipment. Make sure correct information is in setup.</p>
<p>Cannot boot system after installing second hard drive.</p>	<ol style="list-style-type: none"> 1. Set master/slave jumpers correctly. 2. Run SETUP program and select correct drive types. Call the drive manufacturers for compatibility with other drives.

This page is intentionally left blank

APPENDENCIES: SPEC IN OTHER LANGUAGE

GERMAN

	<i>TForce P965 Deluxe</i>	<i>TForce 965PT</i>
CPU	LGA 775 Intel Core2Duo / Pentium 4 / Pentium D / Celeron D Prozessoren mit bis zu 3,8 GHz Unterstützt Hyper-Threading / Execute Disable Bit / Enhanced Intel SpeedStep® / Intel Architecture-64 / Extended Memory 64 Technology / Virtualization Technology	LGA 775 Intel Core2Duo / Pentium 4 / Pentium D / Celeron D Prozessoren mit bis zu 3,8 GHz Unterstützt Hyper-Threading / Execute Disable Bit / Enhanced Intel SpeedStep® / Intel Architecture-64 / Extended Memory 64 Technology / Virtualization Technology
FSB	533 / 800 / 1066 MHz	533 / 800 / 1066 MHz
Chipsatz	Intel P965 Intel ICH8R	Intel P965 Intel ICH8
Super E/A	ITE 8718F Bietet die häufig verwendeten alten Super E/A-Funktionen. Low Pin Court-Schnittstelle Umgebungs-kontrolle, Hardware-Überwachung Lüfterdrehzahl-Controller "Smart Guardian"-Funktion von ITE	ITE 8718F Bietet die häufig verwendeten alten Super E/A-Funktionen. Low Pin Court-Schnittstelle Umgebungs-kontrolle, Hardware-Überwachung Lüfterdrehzahl-Controller "Smart Guardian"-Funktion von ITE
Arbeitsspeicher	DDR2 DIMM-Steckplätze x 4 Jeder DIMM unterstützt 256/512MB / 1GB / 2GB DDR2. Max. 8GB Arbeitsspeicher Dual-Kanal DDR2 Speichermodul Unterstützt DDR2 533 / 667 / 800 registrierte DIMMs. ECC DIMMs werden nicht unterstützt.	DDR2 DIMM-Steckplätze x 4 Jeder DIMM unterstützt 256/512MB / 1GB / 2GB DDR2. Max. 8GB Arbeitsspeicher Dual-Kanal DDR2 Speichermodul Unterstützt DDR2 533 / 667 / 800 registrierte DIMMs. ECC DIMMs werden nicht unterstützt.
IDE	VIA VT6410 Ultra DMA 33 / 66 / 100 / 133 Bus Master-Modus Unterstützt PIO-Modus 0~4,	VIA VT6410 Ultra DMA 33 / 66 / 100 / 133 Bus Master-Modus Unterstützt PIO-Modus 0~4,
SATA II	Integrierter Serial ATA-Controller Daten-transfer-rate bis zu 3Gb/s Konform mit der SATA-Spezifikation Version 2.0.	Integrierter Serial ATA-Controller Daten-transfer-rate bis zu 3Gb/s Konform mit der SATA-Spezifikation Version 2.0.
LAN	Realtek RTL 8110SC 10 / 100 Mb/s und 1Gb/s Auto-Negotiation Halb-/Voll-duplex-Funktion	Realtek RTL 8110SC 10 / 100 Mb/s und 1Gb/s Auto-Negotiation Halb-/Voll-duplex-Funktion
HD	ALC883 Audio-Unters: 8+2-Kanal-Audioausgabe	ALC883 8+2-Kanal-Audioausgabe

TForce P965 Deluxe/TForce 965PT

	<i>TForce P965 Deluxe</i>	<i>TForce 965PT</i>
Unterstützung	Unterstützt Intel High-Definition Audio	Unterstützt Intel High-Definition Audio
Steckplätze	PCI-Steckplatz x3	PCI-Steckplatz x3
	PCI Express x16 Steckplatz x1	PCI Express x16 Steckplatz x1
	PCI Express x4 Steckplatz x1	PCI Express x4 Steckplatz x1
	PCI Express x 1-Steckplatz x1	PCI Express x 1-Steckplatz x1
Onboard-Anschluss	Diskettenlaufwerkanschluss x1	Diskettenlaufwerkanschluss x1
	Druckeranschluss Anschluss x1	Druckeranschluss Anschluss x1
	IDE-Anschluss x1	IDE-Anschluss x1
	SATA-Anschluss x6	SATA-Anschluss x4
	Fronttafelanschluss x1	Fronttafelanschluss x1
	Front-Audioanschluss x1	Front-Audioanschluss x1
	CD-IN-Anschluss x1	CD-IN-Anschluss x1
	S/PDIF- Ausgangsanschluss x1	S/PDIF- Ausgangsanschluss x1
	S/PDIF Eingangsanschluss x1	S/PDIF Eingangsanschluss x1
	CPU-Lüfter-Sockel x1	CPU-Lüfter-Sockel x1
	System-Lüfter-Sockel x2	System-Lüfter-Sockel x2
	"CMOS löschen"-Sockel x1	"CMOS löschen"-Sockel x1
	USB-Anschluss x2	USB-Anschluss x2
	Stromanschluss (24-polig) x1	Stromanschluss (24-polig) x1
Stromanschluss (4-polig) x1	Stromanschluss (4-polig) x1	
Rückseiten-E/A	PS/2-Tastatur x1	PS/2-Tastatur x1
	PS/2-Maus x1	PS/2-Maus x1
	Serieller Anschluss x1	Serieller Anschluss x1
	LAN-Anschluss x1	LAN-Anschluss x1
	USB-Anschluss x6	USB-Anschluss x6
Platinengröße	220 mm (B) X 305 mm (L)	220 mm (B) X 305 mm (L)
Sonderfunktionen	Unterstützt RAID 0 / 1/ 5 / 1+0	
OS-Unterstützung	Windows 2000 / XP Biostar behält sich das Recht vor, ohne Ankündigung die Unterstützung für ein Betriebssystem hinzuzufügen oder zu entfernen.	Windows 2000 / XP Biostar behält sich das Recht vor, ohne Ankündigung die Unterstützung für ein Betriebssystem hinzuzufügen oder zu entfernen.

FRANCE

	<i>TForce P965 Deluxe</i>	<i>TForce 965PT</i>
UC	LGA 775 Processeurs Intel Core2Duo / Pentium 4 / Pentium D / Celeron D jusqu'à 3,8 GHz Prend en charge les technologies Hyper-Threading / d'exécution de bit de désactivation / Intel SpeedStep® optimisée/ d'architecture Intel 64 / de mémoire étendue 64 / de virtualisation	LGA 775 Processeurs Intel Core2Duo / Pentium 4 / Pentium D / Celeron D jusqu'à 3,8 GHz Prend en charge les technologies Hyper-Threading / d'exécution de bit de désactivation / Intel SpeedStep® optimisée/ d'architecture Intel 64 / de mémoire étendue 64 / de virtualisation
Bus frontal	533 / 800 / 1066 MHz	533 / 800 / 1066 MHz
Chipset	Intel P965 Intel ICH8R	Intel P965 Intel ICH8
Super E/S	ITE 8718F Fournit la fonctionnalité de Super E/S patrimoniales la plus utilisée. Interface à faible compte de broches Initiatives de contrôle environnementales, Moniteur de matériel Contrôleur de vitesse de ventilateur Fonction "Garden intelligent" de l'ITE	ITE 8718F Fournit la fonctionnalité de Super E/S patrimoniales la plus utilisée. Interface à faible compte de broches Initiatives de contrôle environnementales, Moniteur de matériel Contrôleur de vitesse de ventilateur Fonction "Garden intelligent" de l'ITE
Mémoire principale	Fentes DDR2 DIMM x 4 Chaque DIMM prend en charge des DDR2 de 256/512 Mo 1Go /2Go Capacité mémoire maximale de 8 Go Module de mémoire DDR2 à mode à double voie Prend en charge la DDR2 533 / 667 / 800 Les DIMM à registres et DIMM sans code correcteurs d'erreurs ne sont pas prises en charge	Fentes DDR2 DIMM x 4 Chaque DIMM prend en charge des DDR2 de 256/512 Mo 1Go /2Go Capacité mémoire maximale de 8 Go Module de mémoire DDR2 à mode à double voie Prend en charge la DDR2 533 / 667 / 800 Les DIMM à registres et DIMM sans code correcteurs d'erreurs ne sont pas prises en charge
IDE	VIA VT6410 Mode principale de Bus Ultra DMA 33 / 66 / 100 / 133 Prend en charge le mode PIO 0~4,	VIA VT6410 Mode principale de Bus Ultra DMA 33 / 66 / 100 / 133 Prend en charge le mode PIO 0~4,
SATA SATA II	Contrôleur Serial ATA intégré : Taux de transfert jusqu'à 3 Go/s. Conforme à la spécification SATA Version 2.0	Contrôleur Serial ATA intégré : Taux de transfert jusqu'à 3 Go/s. Conforme à la spécification SATA Version 2.0
LAN	Realtek RTL 8110SC 10 / 100 Mb/s et 1 Gb/s négociation automatique Half / Full duplex capability	Realtek RTL 8110SC 10 / 100 Mb/s et 1 Gb/s négociation automatique Half / Full duplex capability

TForce P965 Deluxe/TForce 965PT

	<i>TForce P965 Deluxe</i>	<i>TForce 965PT</i>
Prise en charge audio HD	ALC883 Sortie audio à 8+2 voies Prise en charge de l'audio haute définition Intel	ALC883 Sortie audio à 8+2 voies Prise en charge de l'audio haute définition Intel
Fentes	Fente PCI x3 Slot PCI Express x16 x1 Slot PCI Express x 4 x1 Slot PCI Express x 1 x1	Fente PCI x3 Slot PCI Express x16 x1 Slot PCI Express x 4 x1 Slot PCI Express x 1 x1
Connecteur embarqué	Connecteur de disquette x1 Connecteur de Port d'imprimante x1 Connecteur IDE x1 Connecteur SATA x6 Connecteur du panneau avant x1 Connecteur Audio du panneau avant x1 Connecteur d'entrée CD x1 Connecteur de sortie S/PDIF x1 Connecteur d'entrée S/PDIF x1 Embase de ventilateur UC x1 Embase de ventilateur système x2 Embase d'effacement CMOS x1 Connecteur USB x2 Connecteur d'alimentation x1 (24 broches) Connecteur d'alimentation x1 (4 broches)	Connecteur de disquette x1 Connecteur de Port d'imprimante x1 Connecteur IDE x1 Connecteur SATA x4 Connecteur du panneau avant x1 Connecteur Audio du panneau avant x1 Connecteur d'entrée CD x1 Connecteur de sortie S/PDIF x1 Connecteur d'entrée S/PDIF x1 Embase de ventilateur UC x1 Embase de ventilateur système x2 Embase d'effacement CMOS x1 Connecteur USB x2 Connecteur d'alimentation x1 (24 broches) Connecteur d'alimentation x1 (4 broches)
E/S du panneau arrière	Clavier PS/2 x1 Souris PS/2 x1 Port série x1 Port LAN x1 Port USB x6 Fiche audio x6	Clavier PS/2 x1 Souris PS/2 x1 Port série x1 Port LAN x1 Port USB x6 Fiche audio x6
Dimensions de la carte	220 mm (l) X 305 mm (H)	220 mm (l) X 305 mm (H)
Fonctionnalités spéciales	Prise en charge RAID 0 / 1 / 5 / 1+0	
Support SE	Windows 2000 / XP Biostar se réserve le droit d'ajouter ou de supprimer le support de SE avec ou sans préavis.	Windows 2000 / XP Biostar se réserve le droit d'ajouter ou de supprimer le support de SE avec ou sans préavis.

ITALIAN

	<i>TForce P965 Deluxe</i>	<i>TForce 965PT</i>
CPU	LGA 775 Processore Intel Core2Duo / Pentium 4 / Pentium D / Celeron D fino a 3.8 GHz Supporto di Hyper-Threading / Execute Disable Bit / Enhanced Intel SpeedStep® / Architettura Intel 64 / Tecnologia Extended Memory 64 / Tecnologia Virtualization	LGA 775 Processore Intel Core2Duo / Pentium 4 / Pentium D / Celeron D fino a 3.8 GHz Supporto di Hyper-Threading / Execute Disable Bit / Enhanced Intel SpeedStep® / Architettura Intel 64 / Tecnologia Extended Memory 64 / Tecnologia Virtualization
FSB	533 / 800 / 1066 MHz	533 / 800 / 1066 MHz
Chipset	Intel P965 Intel ICH8R	Intel P965 Intel ICH8
Super I/O	ITE 8718F Fornisce le funzionalità legacy Super I/O usate più comunemente. Interfaccia LPC (Low Pin Count) Funzioni di controllo dell'ambiente: Monitoraggio hardware Controller velocità ventolina Funzione "Smart Guardian" di ITE	ITE 8718F Fornisce le funzionalità legacy Super I/O usate più comunemente. Interfaccia LPC (Low Pin Count) Funzioni di controllo dell'ambiente: Monitoraggio hardware Controller velocità ventolina Funzione "Smart Guardian" di ITE
Memoria principale	Alloggi DIMM DDR2 x 4 Ciascun DIMM supporta DDR2 256/512MB / 1GB / 2GB Capacità massima della memoria 8GB Modulo di memoria DDR2 a canale doppio Supporto di DDR2 533 / 667 / 800 DIMM registrati e DIMM ECC sono supportati	Alloggi DIMM DDR2 x 4 Ciascun DIMM supporta DDR2 256/512MB / 1GB / 2GB Capacità massima della memoria 8GB Modulo di memoria DDR2 a canale doppio Supporto di DDR2 533 / 667 / 800 DIMM registrati e DIMM ECC sono supportati
IDE	VIA VT6410 Modalità Bus Master Ultra DMA 33 / 66 / 100 / 133 Supporto modalità PIO Mode 0-4	VIA VT6410 Modalità Bus Master Ultra DMA 33 / 66 / 100 / 133 Supporto modalità PIO Mode 0-4
SATA II	Velocità di trasferimento dei dati fino a 3 Gb/s. Compatibile specifiche SATA Versione 2.0.	Velocità di trasferimento dei dati fino a 3 Gb/s. Compatibile specifiche SATA Versione 2.0.
LAN	Realtek RTL 8110SC Negoziazione automatica 10 / 100Mb/s e 1Gb/s Capacità Half / Full Duplex	Realtek RTL 8110SC Negoziazione automatica 10 / 100Mb/s e 1Gb/s Capacità Half / Full Duplex
Supporto audio HD	ALC883 Uscita audio 8+2 canali Supporto audio High-Definition (HD)	ALC883 Uscita audio 8+2 canali Supporto audio High-Definition (HD)
Alloggi	Alloggio PCI x3	Alloggio PCI x3

TForce P965 Deluxe/TForce 965PT

	<i>TForce P965 Deluxe</i>		<i>TForce 965PT</i>	
	Alloggio PCI Express x16	x1	Alloggio PCI Express x16	x1
	Alloggio PCI Express x4	x1	Alloggio PCI Express x4	x1
	Alloggio PCI Express x1	x1	Alloggio PCI Express x1	x1
Connettori su scheda	Connettore floppy	x1	Connettore floppy	x1
	Connettore Porta stampante	x1	Connettore Porta stampante	x1
	Connettore IDE	x1	Connettore IDE	x1
	Connettore SATA	x6	Connettore SATA	x4
	Connettore pannello frontale	x1	Connettore pannello frontale	x1
	Connettore audio frontale	x1	Connettore audio frontale	x1
	Connettore CD-in	x1	Connettore CD-in	x1
	Connettore output SPDIF	x1	Connettore output SPDIF	x1
	Connettore input S/PDIF	x1	Connettore input S/PDIF	x1
	Collettore ventolina CPU	x1	Collettore ventolina CPU	x1
	Collettore ventolina sistema	x2	Collettore ventolina sistema	x2
	Collettore cancellazione CMOS	x1	Collettore cancellazione CMOS	x1
	Connettore USB	x2	Connettore USB	x2
Connettore alimentazione (24 pin)	x1	Connettore alimentazione (24 pin)	x1	
Connettore alimentazione (4 pin)	x1	Connettore alimentazione (4 pin)	x1	
I/O pannello posteriore	Tastiera PS/2	x1	Tastiera PS/2	x1
	Mouse PS/2	x1	Mouse PS/2	x1
	Porta seriale	x1	Porta seriale	x1
	Porta LAN	x1	Porta LAN	x1
	Porta USB	x6	Porta USB	x6
	Connettore audio	x6	Connettore audio	x6
Dimensioni scheda	220 mm (larghezza) x 305 mm (altezza)		220 mm (larghezza) x 305 mm (altezza)	
Caratteristiche speciali	Supporto RAID 0 / 1 / 5 / 1+0			
Sistemi operativi supportati	Windows 2000 / XP Biostar si riserva il diritto di aggiungere o rimuovere il supporto di qualsiasi sistema operativo senza preavviso.		Windows 2000 / XP Biostar si riserva il diritto di aggiungere o rimuovere il supporto di qualsiasi sistema operativo senza preavviso.	

SPANISH

	<i>TForce P965 Deluxe</i>	<i>TForce 965PT</i>
CPU	LGA 775 Procesador Intel Core2Duo / Pentium 4 / Pentium D / Celeron D hasta 3,8 GHz Admite Hyper-Threading / Bit de deshabilitación de ejecución / Intel SpeedStep® Mejorado / Intel Architecture-64 / Tecnología Extended Memory 64 / Tecnología de virtualización	LGA 775 Procesador Intel Core2Duo / Pentium 4 / Pentium D / Celeron D hasta 3,8 GHz Admite Hyper-Threading / Bit de deshabilitación de ejecución / Intel SpeedStep® Mejorado / Intel Architecture-64 / Tecnología Extended Memory 64 / Tecnología de virtualización
FSB	533 / 800 / 1066 MHz	533 / 800 / 1066 MHz
Conjunto de chips	Intel P965 Intel ICH8R	Intel P965 Intel ICH8
Súper E/S	ITE 8718F Le ofrece las funcionalidades heredadas de uso más común Súper E/S. Interfaz de cuenta Low Pin Iniciativas de control de entorno, Monitor hardware Controlador de velocidad de ventilador Función "Guarda inteligente" de ITE	ITE 8718F Le ofrece las funcionalidades heredadas de uso más común Súper E/S. Interfaz de cuenta Low Pin Iniciativas de control de entorno, Monitor hardware Controlador de velocidad de ventilador Función "Guarda inteligente" de ITE
Memoria principal	Ranuras DIMM DDR2 x 4 Cada DIMM admite DDR de 256/512MB / 1GB / 2GB Capacidad máxima de memoria de 8GB Módulo de memoria DDR2 de canal Doble Admite DDR2 de 533 / 667 / 800 No admite DIMM registrados o DIMM no compatibles con ECC	Ranuras DIMM DDR2 x 4 Cada DIMM admite DDR de 256/512MB / 1GB / 2GB Capacidad máxima de memoria de 8GB Módulo de memoria DDR2 de canal Doble Admite DDR2 de 533 / 667 / 800 No admite DIMM registrados o DIMM no compatibles con ECC
IDE	VIA VT6410 Modo bus maestro Ultra DMA 33 / 66 / 100 / 133 Soporte los Modos PIO 0~4,	VIA VT6410 Modo bus maestro Ultra DMA 33 / 66 / 100 / 133 Soporte los Modos PIO 0~4,
SATA II	Controlador ATA Serie Integrado Tasas de transferencia de hasta 3 Gb/s. Compatible con la versión SATA 2.0.	Controlador ATA Serie Integrado Tasas de transferencia de hasta 3 Gb/s. Compatible con la versión SATA 2.0.
Red Local	Realtek RTL 8110SC Negociación de 10 / 100 Mb/s y 1 Gb/s Funciones Half / Full dúplex	Realtek RTL 8110SC Negociación de 10 / 100 Mb/s y 1 Gb/s Funciones Half / Full dúplex
Soporte de sonido HD	ALC883 Salida de sonido de 8+2 canales Soporte de sonido Intel de Alta Definición	ALC883 Salida de sonido de 8+2 canales Soporte de sonido Intel de Alta Definición
Ranuras	Ranura PCI X3 Ranura PCI Express x16 X1	Ranura PCI X3 Ranura PCI Express x16 X1

TForce P965 Deluxe/TForce 965PT

	<i>TForce P965 Deluxe</i>		<i>TForce 965PT</i>	
	Ranura PCI Express x4	X1	Ranura PCI Express x4	X1
	Ranura PCI express x 1	X1	Ranura PCI express x 1	X1
Conectores en placa	Conector disco flexible	X1	Conector disco flexible	X1
	Conector Puerto de impresora	X1	Conector Puerto de impresora	X1
	Conector IDE	X1	Conector IDE	X1
	Conector SATA	X6	Conector SATA	X4
	Conector de panel frontal	X1	Conector de panel frontal	X1
	Conector de sonido frontal	X1	Conector de sonido frontal	X1
	Conector de entrada de CD	X1	Conector de entrada de CD	X1
	Conector de salida S/PDIF	X1	Conector de salida S/PDIF	X1
	Cabecera de ventilador de CPU	X1	Cabecera de ventilador de CPU	X1
	Cabecera de ventilador de sistema	X2	Cabecera de ventilador de sistema	X2
	Cabecera de borrado de CMOS	X1	Cabecera de borrado de CMOS	X1
	Conector USB	X2	Conector USB	X2
	Conector de alimentación (24 patillas)	X1	Conector de alimentación (24 patillas)	X1
	Conector de alimentación (4 patillas)	X1	Conector de alimentación (4 patillas)	X1
Panel trasero de E/S	Teclado PS/2	X1	Teclado PS/2	X1
	Ratón PS/2	X1	Ratón PS/2	X1
	Puerto serie	X1	Puerto serie	X1
	Puerto de red local	X1	Puerto de red local	X1
	Puerto USB	X6	Puerto USB	X6
	Conector de sonido	X6	Conector de sonido	X6
Tamaño de la placa	220 mm. (A) X 305Mm. (H)		220 mm. (A) X 305Mm. (H)	
Funciones especiales	Admite RAID 0 / 1 / 5 / 1+0			
Soporte de sistema operativo	Windows 2000 / XP Bióstar se reserva el derecho de añadir o retirar el soporte de cualquier SO con o sin aviso previo.		Windows 2000 / XP Bióstar se reserva el derecho de añadir o retirar el soporte de cualquier SO con o sin aviso previo.	

PORTUGUESE

	<i>TForce P965 Deluxe</i>	<i>TForce 965PT</i>
CPU	LGA 775 Processador Intel Core2Duo / Pentium 4 / Pentium D / Celeron D até 3,8 GHz Suporta as tecnologias Hyper-Threading / Execute Disable Bit / Enhanced Intel SpeedStep® / Intel Architecture -64 / Extended Memory 64 / Virtualization	LGA 775 Processador Intel Core2Duo / Pentium 4 / Pentium D / Celeron D até 3,8 GHz Suporta as tecnologias Hyper-Threading / Execute Disable Bit / Enhanced Intel SpeedStep® / Intel Architecture -64 / Extended Memory 64 / Virtualization
FSB	533 / 800 / 1066 MHz	533 / 800 / 1066 MHz
Chipset	Intel P965 Intel ICH8R	Intel P965 Intel ICH8
Especificação do Super I/O	ITE 8718F Proporciona as funcionalidades mais utilizadas em termos da especificação Super I/O. Interface LPC (Low Pin Count). Iniciativas para controlo do ambiente Monitorização do hardware Controlador da velocidade da ventoinha Função "Smart Guardian" da ITE	ITE 8718F Proporciona as funcionalidades mais utilizadas em termos da especificação Super I/O. Interface LPC (Low Pin Count). Iniciativas para controlo do ambiente Monitorização do hardware Controlador da velocidade da ventoinha Função "Smart Guardian" da ITE
Memória principal	Ranuras DIMM DDR2 x 4 Cada módulo DIMM suporta uma memória DDR2 de 256/512 MB / 1 GB / 2GB Capacidade máxima de memória: 8 GB Módulo de memória DDR2 de canal duplo Suporta módulos DDR2 533 / 667 / 800 Os módulos DIMM registados e os DIMM ECCsão suportados	Ranuras DIMM DDR2 x 4 Cada módulo DIMM suporta uma memória DDR2 de 256/512 MB / 1 GB / 2GB Capacidade máxima de memória: 8 GB Módulo de memória DDR2 de canal duplo Suporta módulos DDR2 533 / 667 / 800 Os módulos DIMM registados e os DIMM ECCsão suportados
IDE	VIA VT6410 Modo Bus master Ultra DMA 33 / 66 / 100 / 133 Suporta o modo PIO 0~4,	VIA VT6410 Modo Bus master Ultra DMA 33 / 66 / 100 / 133 Suporta o modo PIO 0~4,
SATA II	Controlador Serial ATA integrado Velocidades de transmissão de dados até 3 Gb/s. Compatibilidade com a especificação SATA versão 2.0.	Controlador Serial ATA integrado Velocidades de transmissão de dados até 3 Gb/s. Compatibilidade com a especificação SATA versão 2.0.
LAN	Realtek RTL 8110SC Auto negociação de 10 / 100 Mb/s e 1Gb/s Capacidade semi/full-duplex	Realtek RTL 8110SC Auto negociação de 10 / 100 Mb/s e 1Gb/s Capacidade semi/full-duplex
Suporte para áudio de alta definição	ALC883 Saída de áudio de 8+2 canais Suporta a especificação Intel High-Definition Audio	ALC883 Saída de áudio de 8+2 canais Suporta a especificação Intel High-Definition Audio
Ranuras	Ranura PCI x3 Ranura PCI Express x16 x1	Ranura PCI x3 Ranura PCI Express x16 x1

TForce P965 Deluxe/TForce 965PT

	<i>TForce P965 Deluxe</i>	<i>TForce 965PT</i>
	Ranhura PCI Express x4 x1	Ranhura PCI Express x4 x1
	Ranhura PCI Express x 1 x1	Ranhura PCI Express x 1 x1
Conectores na placa	Conector da unidade de disquetes x1	Conector da unidade de disquetes x1
	Conector da para impressora x1	Conector da para impressora x1
	Conector IDE x1	Conector IDE x1
	Conector SATA x6	Conector SATA x4
	Conector do painel frontal x1	Conector do painel frontal x1
	Conector de áudio frontal x1	Conector de áudio frontal x1
	Conector para entrada de CDs x1	Conector para entrada de CDs x1
	Conector de saída S/PDIF x1	Conector de saída S/PDIF x1
	Conector de entrada S/PDIF x1	Conector de entrada S/PDIF x1
	Conector da verticinha da CPU x1	Conector da verticinha da CPU x1
	Conector da verticinha do sistema x2	Conector da verticinha do sistema x2
	Conector para limpeza do CMOS x1	Conector para limpeza do CMOS x1
	Conector USB x2	Conector USB x2
	Conector de alimentação (24 pinos) x1	Conector de alimentação (24 pinos) x1
Conector de alimentação (4 pinos) x1	Conector de alimentação (4 pinos) x1	
Entradas/Saídas no painel traseiro	Teclado PS/2 x1	Teclado PS/2 x1
	Rato PS/2 x1	Rato PS/2 x1
	Porta série x1	Porta série x1
	Porta LAN x1	Porta LAN x1
	Porta USB x6	Porta USB x6
	Tomada de áudio x6	Tomada de áudio x6
Tamanho da placa	220 mm (L) X 305mm (A)	220 mm (L) X 305mm (A)
Características especiais	Suporta as funções RAID 0 / 1 / 5 / 1+0	
Sistemas operativos suportados	Windows 2000 / XP A Biostar reserva-se o direito de adicionar ou remover suporte para qualquer sistema operativo com ou sem aviso prévio.	Windows 2000 / XP A Biostar reserva-se o direito de adicionar ou remover suporte para qualquer sistema operativo com ou sem aviso prévio.

POLISH

	TForce P965 Deluxe	TForce 965PT
Procesor	LGA 775 Procesor Intel Core2Duo / Pentium 4 / Pentium D / Celeron D do 3,8 GHz Obsługa Hyper-Threading / Execute Disable Bit / Enhanced Intel SpeedStep® / Intel Architecture-64 / Extended Memory 64 Technology / Virtualization Technology	LGA 775 Procesor Intel Core2Duo / Pentium 4 / Pentium D / Celeron D do 3,8 GHz Obsługa Hyper-Threading / Execute Disable Bit / Enhanced Intel SpeedStep® / Intel Architecture-64 / Extended Memory 64 Technology / Virtualization Technology
FSB	533 / 800 / 1066 MHz	533 / 800 / 1066 MHz
Chipset	Intel P965 Intel ICH8R	Intel P965 Intel ICH8
Pamięć główna	Gniazda DDR2 DIMM x 4 Każde gniazdo DIMM obsługuje moduły 256/512MB / 1GB / 2GB DDR2 Maks. wielkość pamięci 8GB Moduł pamięci DDR2 z trybem podwójnego kanału Obsługa DDR2 533 / 667 / 800 Brak obsługi Registered DIMM oraz ECC DIMM	Gniazda DDR2 DIMM x 4 Każde gniazdo DIMM obsługuje moduły 256/512MB / 1GB / 2GB DDR2 Maks. wielkość pamięci 8GB Moduł pamięci DDR2 z trybem podwójnego kanału Obsługa DDR2 533 / 667 / 800 Brak obsługi Registered DIMM oraz ECC DIMM
Super I/O	ITE 8718F Zapewnia najbardziej powszechne funkcje Super I/O. Interfejs Low Pin Court Funkcje kontroli warunków pracy, Monitor H/W Kontroler prędkości wentylatora Funkcja ITE "Smart Guardian"	ITE 8718F Zapewnia najbardziej powszechne funkcje Super I/O. Interfejs Low Pin Court Funkcje kontroli warunków pracy, Monitor H/W Kontroler prędkości wentylatora Funkcja ITE "Smart Guardian"
IDE	VIA VT6410 Ultra DMA 33 / 66 / 100 / 133 Tryb Bus Master obsługa PIO tryb 0~4,	VIA VT6410 Ultra DMA 33 / 66 / 100 / 133 Tryb Bus Master obsługa PIO tryb 0~4,
SATA II	Zintegrowany kontroler Serial ATA Transfer danych do 3 Gb/s. Zgodność ze specyfikacją SATA w wersji 2.0.	Zintegrowany kontroler Serial ATA Transfer danych do 3 Gb/s. Zgodność ze specyfikacją SATA w wersji 2.0.
LAN	Realtek RTL 8110SC 10 / 100 Mb/s oraz 1Gb/s z automatyczną negocjacją szybkości	Realtek RTL 8110SC 10 / 100 Mb/s oraz 1Gb/s z automatyczną negocjacją szybkości
Obsługa audio HD	ALC883 8+2 kanałowe wyjście audio Obsługa Intel High-Definition Audio	ALC883 8+2 kanałowe wyjście audio Obsługa Intel High-Definition Audio
Gniazda	Gniazdo PCI x3 Gniazdo PCI Express x16 x1	Gniazdo PCI x3 Gniazdo PCI Express x16 x1

TForce P965 Deluxe/TForce 965PT

	<i>TForce P965 Deluxe</i>	<i>TForce 965PT</i>
	Gniazdo PCI Express x 4 x1	Gniazdo PCI Express x 4 x1
	Gniazdo PCI Express x 1 x1	Gniazdo PCI Express x 1 x1
Złącza wbudowane	Złącze napędu dyskiętek x1	Złącze napędu dyskiętek x1
	Złącze Port drukarki x1	Złącze Port drukarki x1
	Złącze IDE x1	Złącze IDE x1
	Złącze SATA x6	Złącze SATA x4
	Złącze panela przedniego x1	Złącze panela przedniego x1
	Przednie złącze audio x1	Przednie złącze audio x1
	Złącze wejścia CD x1	Złącze wejścia CD x1
	Złącze wyjścia S/PDIF x1	Złącze wyjścia S/PDIF x1
	Złącze wejścia S/PDIF x1	Złącze wejścia S/PDIF x1
	Złącze głośnikowe wentylatora procesora x1	Złącze głośnikowe wentylatora procesora x1
	Złącze głośnikowe wentylatora systemowego x2	Złącze głośnikowe wentylatora systemowego x2
	Złącze głośnikowe kasowania CMOS x1	Złącze głośnikowe kasowania CMOS x1
	Złącze USB x2	Złącze USB x2
	Złącze zasilania (24 pinowe) x1	Złącze zasilania (24 pinowe) x1
	Złącze zasilania (4 pinowe) x1	Złącze zasilania (4 pinowe) x1
Back Panel I/O	Klawiatura PS/2 x1	Klawiatura PS/2 x1
	Mysz PS/2 x1	Mysz PS/2 x1
	Port szeregowy x1	Port szeregowy x1
	Port LAN x1	Port LAN x1
	Port USB x6	Port USB x6
	Gniazdo audio x6	Gniazdo audio x6
Wymiary płyty	220 mm (S) X 305 mm (W)	220 mm (S) X 305 mm (W)
Funkcje specjalne	Obsługa RAID 0 / 1 / 5 / 1+0	
Obsługa systemu operacyjne go	Windows 2000 / XP Biostar zastrzega sobie prawo dodawania lub odwoływania obsługi dowolnego systemu operacyjnego bez powiadomienia.	Windows 2000 / XP Biostar zastrzega sobie prawo dodawania lub odwoływania obsługi dowolnego systemu operacyjnego bez powiadomienia.

RUSSIAN

	<i>TForce P965 Deluxe</i>	<i>TForce 965PT</i>
CPU (центральный процессор)	LGA 775 Процессор Intel Core2Duo / Pentium 4 / Pentium D / Celeron D до 3.8 ГГц Поддержка технологий Hyper-Threading / Execute Disable Bit / Enhanced Intel SpeedStep® / Intel Architecture-64 / Extended Memory 64 Technology / технологии виртуализация	LGA 775 Процессор Intel Core2Duo / Pentium 4 / Pentium D / Celeron D до 3.8 ГГц Поддержка технологий Hyper-Threading / Execute Disable Bit / Enhanced Intel SpeedStep® / Intel Architecture-64 / Extended Memory 64 Technology / технологии виртуализация
FSB	533 / 800 / 1066 МГц	533 / 800 / 1066 МГц
Набор микросхем	Intel P965 Intel ICH8R	Intel P965 Intel ICH8
Основная память	Слоты DDR2 DIMM x 4 Каждый модуль DIMM поддерживает 256/512МБ / 1ГБ / 2ГБ DDR2 Максимальная ёмкость памяти 8 ГБ Модуль памяти с двухканальным режимом DDR2 Поддержка DDR2 533 / 667 / 800 Не поддерживает зарегистрированные модули DIMM and ECC DIMM	Слоты DDR2 DIMM x 4 Каждый модуль DIMM поддерживает 256/512МБ / 1ГБ / 2ГБ DDR2 Максимальная ёмкость памяти 8 ГБ Модуль памяти с двухканальным режимом DDR2 Поддержка DDR2 533 / 667 / 800 Не поддерживает зарегистрированные модули DIMM and ECC DIMM
Super I/O	ITE 8718F Обеспечивает наиболее используемые действующие функциональные возможности Super I/O. Интерфейс с низким количеством выводов Инициативы по охране окружающей среды, Аппаратный монитор Регулятор скорости Функция ITE "Smart Guardian" (Интеллектуальная защита)	ITE 8718F Обеспечивает наиболее используемые действующие функциональные возможности Super I/O. Интерфейс с низким количеством выводов Инициативы по охране окружающей среды, Аппаратный монитор Регулятор скорости Функция ITE "Smart Guardian" (Интеллектуальная защита)
IDE	VIA VT6410 Режим "хвояина" шины Ultra DMA 33 / 66 / 100 / 133 Поддержка режима PIO 0~4,	VIA VT6410 Режим "хвояина" шины Ultra DMA 33 / 66 / 100 / 133 Поддержка режима PIO 0~4,
SATA II	Встроенное последовательное устройство управления АТА скорость передачи данных до 3 гигабит/с. Соответствие спецификации SATA версия 2.0.	Встроенное последовательное устройство управления АТА скорость передачи данных до 3 гигабит/с. Соответствие спецификации SATA версия 2.0.
Локальная сеть	Realtek RTL 8110SC Автоматическое согласование 10 / 100 Мб/с и 1Гб/с Частичная / полная дуплексная способность	Realtek RTL 8110SC Автоматическое согласование 10 / 100 Мб/с и 1Гб/с Частичная / полная дуплексная способность
Звуковая поддержка жесткого диска	ALC883 Восьмиканальный звуковой выход Звуковая поддержка Intel High-Definition	ALC883 Восьмиканальный звуковой выход Звуковая поддержка Intel High-Definition

TForce P965 Deluxe/TForce 965PT

	<i>TForce P965 Deluxe</i>	<i>TForce 965PT</i>		
Слоты	Слот PCI	x3	Слот PCI	x3
	Слот PCI Express x16	x1	Слот PCI Express x16	x1
	Слот PCI Express x 4	x1	Слот PCI Express x 4	x1
	Слот PCI Express x 1	x1	Слот PCI Express x 1	x1
Встроенны й разъём	Разъём НГМД	x1	Разъём НГМД	x1
	Разъём Порт подключения принтера	x1	Разъём Порт подключения принтера	x1
	Разъём IDE	x1	Разъём IDE	x1
	Разъём SATA	x6	Разъём SATA	x4
	Разъём на лицевой панели	x1	Разъём на лицевой панели	x1
	Входной звуковой разъём	x1	Входной звуковой разъём	x1
	Разъём ввода для CD	x1	Разъём ввода для CD	x1
	Разъём вывода для S/PDIF	x1	Разъём вывода для S/PDIF	x1
	Разъём ввода для S/PDIF	x1	Разъём ввода для S/PDIF	x1
	Контактирующее приспособление вентилятора центрального процессора	x1	Контактирующее приспособление вентилятора центрального процессора	x1
	Контактирующее приспособление вентилятора системы	x2	Контактирующее приспособление вентилятора системы	x2
	Открытое контактирующее приспособление CMOS	x1	Открытое контактирующее приспособление CMOS	x1
	USB-разъём	x2	USB-разъём	x2
Разъём питания (24 вывод)	x1	Разъём питания (24 вывод)	x1	
Разъём питания (4 вывод)	x1	Разъём питания (4 вывод)	x1	
Задняя панель средств ввода-вывода	Клавиатура PS/2	x1	Клавиатура PS/2	x1
	Мышь PS/2	x1	Мышь PS/2	x1
	Последовательный порт	x1	Последовательный порт	x1
	Порт LAN	x1	Порт LAN	x1
	USB-порт	x6	USB-порт	x6
	Гнездо для подключения наушников	x6	Гнездо для подключения наушников	x6
Размер панели	220 мм (Ш) X 305 мм (В)		220 мм (Ш) X 305 мм (В)	
Специальные технические характеристики	Поддержка RAID 0/ 1 / 5 / 1+0			
Поддержка OS	Windows 2000 / XP Bicstar сохраняет за собой право добавлять или удалять средства обеспечения для OS с или без предварительного уведомления.		Windows 2000 / XP Bicstar сохраняет за собой право добавлять или удалять средства обеспечения для OS с или без предварительного уведомления.	

ARABIC

TForce 965PT	TForce P965 Deluxe	
LGA 775 معالجات Intel Core2Duo/ Pentium 4/ Pentium D/ Celeron D وتردد يصل إلى 3.8 جيجا هرتز Hyper-Threading / Execute Disable Bit / Enhanced Intel SpeedStep® / Intel Architecture-64 / Extended Memory 64 Technology / Virtualization Technology	LGA 775 معالجات Intel Core2Duo/ Pentium 4/ Pentium D/ Celeron D وتردد يصل إلى 3.8 جيجا هرتز Hyper-Threading / Execute Disable Bit / Enhanced Intel SpeedStep® / Intel Architecture-64 / Extended Memory 64 Technology / Virtualization Technology	وحدة لمعالجة المركبة
533 / 800 / 1066 ميجا هرتز تردد	533 / 800 / 1066 ميجا هرتز تردد	النقل الأمامي لجلبني
Intel P965 Intel ICH8	Intel P965 Intel ICH8R	مجموعة لشراخ
عدد 4 فتحة DDR2 DIMM ميجا 256/512 سعة DDR2 بلت 2 وبلت 1 جيجا بايت سعة ذاكرة قصوى 8 جيجا بايت مزوجة لفتحة DDR2 وحدة ذاكرة ساعات 800 / 667 / 533 ميجا بايت DDR2 ECC ونك التي لا تتوافق مع DIMM لا تدعم رفلق الذاكرة	عدد 4 فتحة DDR2 DIMM ميجا 256/512 سعة DDR2 بلت 2 وبلت 1 جيجا بايت سعة ذاكرة قصوى 8 جيجا بايت مزوجة لفتحة DDR2 وحدة ذاكرة ساعات 800 / 667 / 533 ميجا بايت DDR2 ECC ونك التي لا تتوافق مع DIMM لا تدعم رفلق الذاكرة	الذاكرة الرئيسية
ITE 8718F الأكثر استخداماً Super I/O ووظيفة Low Pin Count Interface تدعم تقنية وسائل لتحكم في البيئة مراقب لمعوية حلقة الأجهزة مراقب في سرعة لمروحة ITE من "Smart Guardian" ووظيفة	ITE 8718F الأكثر استخداماً Super I/O ووظيفة Low Pin Count Interface تدعم تقنية وسائل لتحكم في البيئة مراقب لمعوية حلقة الأجهزة مراقب في سرعة لمروحة ITE من "Smart Guardian" ووظيفة	Super I/O
VIA VT6410 متحكم IDE Ultra DMA 33 / 66 / 100 / 133 نقل بتقنية وضع رئيسي PIO Mode 0~4 دعم وضع	VIA VT6410 متحكم IDE Ultra DMA 33 / 66 / 100 / 133 نقل بتقنية وضع رئيسي PIO Mode 0~4 دعم وضع	منفذ IDE
متكامل Serial ATA متحكم نقل البيانات بسرعات تصل إلى 3 جيجابت/ثانية. الإصدار SATA مطابقة لمواصفات 2.0	متكامل Serial ATA متحكم نقل البيانات بسرعات تصل إلى 3 جيجابت/ثانية. الإصدار SATA مطابقة لمواصفات 2.0	SATA II
Realtek RTL 8110SC تقويض قطني 100/10 ميجا بايت /ثانية و1 جيجا بايت/ثانية إمكانية النقل لمزوج الكامل/القصي	Realtek RTL 8110SC تقويض قطني 100/10 ميجا بايت /ثانية و1 جيجا بايت/ثانية إمكانية النقل لمزوج الكامل/القصي	شبكة داخلية
ALC883 2+8 قنوات لخرج الصوت	ALC883 2+8 قنوات لخرج الصوت	دعم لصوت عالي التعريف

TForce P965 Deluxe/TForce 965PT

TForce 965PT		TForce P965 Deluxe		
Intel دعم تقنية الصوت على تعريف من		Intel دعم تقنية الصوت على تعريف من		
عدد 3	فتحة PCI	عدد 3	فتحة PCI	الفتحات
عدد 1	فتحة PCI Expressx16	عدد 1	فتحة PCI Expressx16	
عدد 1	فتحة PCI Expressx4	عدد 1	فتحة PCI Expressx4	
عدد 1	فتحة PCI Express x1	عدد 1	فتحة PCI Express x1	
عدد 1	مقعد محرك أقراص مرنة	عدد 1	مقعد محرك أقراص مرنة	المنافذ على سطح اللوحة
عدد 1	مقعد طابعة	عدد 1	مقعد طابعة	
عدد 1	مقعد IDE	عدد 1	مقعد IDE	
عدد 4	مقعد SATA	عدد 6	مقعد SATA	
عدد 1	مقعد اللوحة الأممية	عدد 1	مقعد اللوحة الأممية	
عدد 1	مقعد الصوت الأممي	عدد 1	مقعد الصوت الأممي	
عدد 1	مقعد CD-IN	عدد 1	مقعد CD-IN	
عدد 1	مقعد خرج S/PDIF	عدد 1	مقعد خرج S/PDIF	
عدد 1	مقعد دخل S/PDIF	عدد 1	مقعد دخل S/PDIF	
عدد 1	وصلة مروحة وحدة المعالجة المركزية	عدد 1	وصلة مروحة وحدة المعالجة المركزية	
عدد 2	وصلة مروحة النظم	عدد 2	وصلة مروحة النظم	
عدد 1	وصلة مسح CMOS	عدد 1	وصلة مسح CMOS	
عدد 2	مقعد USB	عدد 2	مقعد USB	
عدد 1	مقعد توصيل الطاقة (24دوس)	عدد 1	مقعد توصيل الطاقة (24دوس)	
عدد 1	مقعد توصيل الطاقة (4دبليس)	عدد 1	مقعد توصيل الطاقة (4دبليس)	
عدد 1	لوحة مفاتيح PS/2	عدد 1	لوحة مفاتيح PS/2	
عدد 1	مؤس PS/2	عدد 1	مؤس PS/2	
عدد 1	مقعد تسلسلي	عدد 1	مقعد تسلسلي	
عدد 1	مقعد شبكة لتصل محلية	عدد 1	مقعد شبكة لتصل محلية	
عدد 6	منافذ USB	عدد 6	منافذ USB	
عدد 6	مقيس صوت	عدد 6	مقيس صوت	
		RAID 0 / 1 / 5 / 1+0 دعم تقنية		مزايا خاصة
220 مم (عرض) X 305 مم (ارتفاع)		220 مم (عرض) X 305 مم (ارتفاع)		حجم اللوحة
Windows 2000 / XP بخطا في اضافة أو إزالة اذع ابي نظام تشغيل باخطل أو Biostar تحفظ بون اخطل.		Windows 2000 / XP بخطا في اضافة أو إزالة اذع ابي نظام تشغيل باخطل أو Biostar تحفظ بون اخطل.		دعم أنظمة تشغيل

JAPANESE

	<i>TForce P965 Deluxe</i>	<i>TForce 965PT</i>
CPU	LGA 775 Intel Core2Duo / Pentium 4 / Pentium D / Celeron D processor up to 3.8 GHz Hyper-Threading / Execute Disable Bit / Enhanced Intel SpeedStep® / Intel Architecture-64 / Extended Memory 64 Technology / Virtualization Technologyをサポート します	LGA 775 Intel Core2Duo / Pentium 4 / Pentium D / Celeron D processor up to 3.8 GHz Hyper-Threading / Execute Disable Bit / Enhanced Intel SpeedStep® / Intel Architecture-64 / Extended Memory 64 Technology / Virtualization Technologyをサポート します
FSB	533 / 800 / 1066 MHz	533 / 800 / 1066 MHz
チップセット	Intel P965 Intel ICH8R	Intel P965 Intel ICH8
メインメモリ	DDR2 DIMMスロット x 4 各DIMMは 256/512MB/1GB/2GB DDR2をサポート 最大メモリ容量8GB デュアルチャンネルモードDDR2メモリモジュール DDR2 533 / 667 / 800をサポート 登録済みDIMMとECC DIMMはサポートされません	DDR2 DIMMスロット x 4 各DIMMは 256/512MB/1GB/2GB DDR2をサポート 最大メモリ容量8GB デュアルチャンネルモードDDR2メモリモジュール DDR2 533 / 667 / 800をサポート 登録済みDIMMとECC DIMMはサポートされません
Super I/O	ITE 8718F もつとも一般に使用されるレガシーSuper I/O機能を 採用しています。 低ピンカウントインターフェイス 環境コントロールイニシアチブ、 H/Wモニター ファン速度コントローラ / モニター ITEの「スマートガーディアン」機能	ITE 8718F もつとも一般に使用されるレガシーSuper I/O機能を 採用しています。 低ピンカウントインターフェイス 環境コントロールイニシアチブ、 H/Wモニター ファン速度コントローラ / モニター ITEの「スマートガーディアン」機能
IDE	VIA VT6410 Ultra DMA 33 / 66 / 100 / 133バスマスタモード PIO Mode 0~4のサポート、	VIA VT6410 Ultra DMA 33 / 66 / 100 / 133バスマスタモード PIO Mode 0~4のサポート、
SATA II	統合シリアルATAコントローラ 最高3 Gb/秒のデータ転送速度 SATAバージョン2.0仕様に準拠。	統合シリアルATAコントローラ 最高3 Gb/秒のデータ転送速度 SATAバージョン2.0仕様に準拠。
LAN	Realtek RTL 8110SC 10 / 100 Mb/秒および1Gb/秒のオートネゴシエー ション 半/全二重機能	Realtek RTL 8110SC 10 / 100 Mb/秒および1Gb/秒のオートネゴシエー ション 半/全二重機能

TForce P965 Deluxe/TForce 965PT

	TForce P965 Deluxe	TForce 965PT
HDオーディオのサポート	ALC883 8+2 チャンネルオーディオアウト Intel/ハイデフィニションオーディオのサポート	ALC883 8+2 チャンネルオーディオアウト Intel/ハイデフィニションオーディオのサポート
スロット	PCIスロット x3 PCI Express x16スロット x1 PCI Express x 4スロット x1 PCI Express x 1スロット x1	PCIスロット x3 PCI Express x16スロット x1 PCI Express x 4スロット x1 PCI Express x 1スロット x1
オンボードコネクタ	フロッピーコネクタ x1 プリンタポートコネクタ x1 IDEコネクタ x1 SATAコネクタ x6 フロントパネルコネクタ x1 フロントオーディオコネクタ x1 CDインコネクタ x1 S/PDIFアウトコネクタ x1 S/PDIFインコネクタ x1 CPUファンヘッダ x1 システムファンヘッダ x2 CMOS クリアヘッダ x1 USBコネクタ x2 電源コネクタ (24ピン) x1 電源コネクタ (4ピン) x1	フロッピーコネクタ x1 プリンタポートコネクタ x1 IDEコネクタ x1 SATAコネクタ x4 フロントパネルコネクタ x1 フロントオーディオコネクタ x1 CDインコネクタ x1 S/PDIFアウトコネクタ x1 S/PDIFインコネクタ x1 CPUファンヘッダ x1 システムファンヘッダ x2 CMOS クリアヘッダ x1 USBコネクタ x2 電源コネクタ (24ピン) x1 電源コネクタ (4ピン) x1
背面パネル I/O	PS/2キーボード x1 PS/2マウス x1 シリアルポート x1 LANポート x1 USBポート x6 オーディオジャック x6	PS/2キーボード x1 PS/2マウス x1 シリアルポート x1 LANポート x1 USBポート x6 オーディオジャック x6
ボードサイズ	220 mm (幅) X 305 mm (高さ)	220 mm (幅) X 305 mm (高さ)
特殊機能	RAID 0 / 1 / 5 / 1+0 のサポート	
OSサポート	Windows 2000 / XP Bicstarは事前のサポートなしにOSサポートを追加または削除する権利を留保します。	Windows 2000 / XP Bicstarは事前のサポートなしにOSサポートを追加または削除する権利を留保します。

2006/08/21

TForce P965 Deluxe BIOS Setup

BIOS Setup.....	1
1 Main Menu	3
2 Standard CMOS Features	7
3 Advanced BIOS Features	9
4 Advanced Chipset Features	16
5 Integrated Peripherals.....	19
6 Power Management Setup.....	24
7 PnP/PCI Configurations	30
8 PC Health Status.....	33
9 Over Clock Navigator.....	36
10 CMOS Reload Program(C.R.P.)	42

TForce P965 Deluxe

BIOS Setup

Introduction

The purpose of this manual is to describe the settings in the Award™ BIOS Setup program on this motherboard. The Setup program allows users to modify the basic system configuration and save these settings to CMOS RAM. The power of CMOS RAM is supplied by a battery so that it retains the Setup information when the power is turned off.

Basic Input-Output System (BIOS) determines what a computer can do without accessing programs from a disk. This system controls most of the input and output devices such as keyboard, mouse, serial ports and disk drives. BIOS activates at the first stage of the booting process, loading and executing the operating system. Some additional features, such as virus and password protection or chipset fine-tuning options are also included in BIOS.

The rest of this manual will to guide you through the options and settings in BIOS Setup.

Plug and Play Support

This AWARD BIOS supports the Plug and Play Version 1.0A specification and ESCD (Extended System Configuration Data) write.

EPA Green PC Support

This AWARD BIOS supports Version 1.03 of the EPA Green PC specification.

APM Support

This AWARD BIOS supports Version 1.1&1.2 of the Advanced Power Management (APM) specification. Power management features are implemented via the System Management Interrupt (SMI). Sleep and Suspend power management modes are supported. Power to the hard disk drives and video monitors can also be managed by this AWARD BIOS.

ACPI Support

Award ACPI BIOS support Version 1.0 of Advanced Configuration and Power interface specification (ACPI). It provides ASL code for power management and device configuration capabilities as defined in the ACPI specification, developed by Microsoft, Intel and Toshiba.

TForce P965 Deluxe

PCI Bus Support

This AWARD BIOS also supports Version 2.1 of the Intel PCI (Peripheral Component Interconnect) local bus specification.

DRAM Support

DDR SDRAM (Double Data Rate Synchronous DRAM) is supported.

Supported CPUs

This AWARD BIOS supports the Intel CPU.

Using Setup

Use the arrow keys to highlight items in most of the place, press <Enter> to select, use the <PgUp> and <PgDn> keys to change entries, press <F1> for help and press <Esc> to quit. The following table provides more detail about how to navigate in the Setup program by using the keyboard.

Keystroke	Function
Up arrow	Move to previous item
Down arrow	Move to next item
Left arrow	Move to the item on the left (menu bar)
Right arrow	Move to the item on the right (menu bar)
Move Enter	Move to the item you desired
PgUp key	Increase the numeric value or make changes
PgDn key	Decrease the numeric value or make changes
+ Key	Increase the numeric value or make changes
- Key	Decrease the numeric value or make changes
Esc key	Main Menu – Quit and not save changes into CMOS Status Page Setup Menu and Option Page Setup Menu – Exit Current page and return to Main Menu
F1 key	General help on Setup navigation keys
F5 key	Load previous values from CMOS
F7 key	Load the optimized defaults
F10 key	Save all the CMOS changes and exit

TForce P965 Deluxe

1 Main Menu

Once you enter Award BIOS™ CMOS Setup Utility, the Main Menu will appear on the screen. The Main Menu allows you to select from several setup functions. Use the arrow keys to select among the items and press <Enter> to accept and enter the sub-menu.

!! WARNING !!

For better system performance, the BIOS firmware is being continuously updated. The BIOS information described in this manual (**Figure 1, 2, 3, 4, 5, 6, 7, 8, 9**) is for your reference only. The actual BIOS information and settings on board may be slightly different from this manual.

■ Figure 1: Main Menu

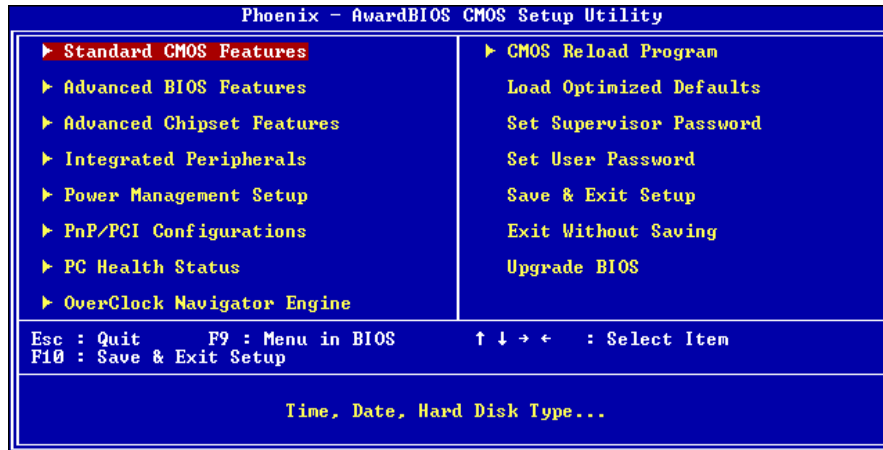

Standard CMOS Features

This submenu contains industry standard configurable options.

Advanced BIOS Features

This submenu allows you to configure advanced features of the BIOS.

TForce P965 Deluxe

Advanced Chipset Features

This submenu allows you to configure special chipset features.

Integrated Peripherals

This submenu allows you to configure certain IDE hard drive options and Programmed Input/ Output features.

Power Management Setup

This submenu allows you to configure the power management features.

PnP/PCI Configurations

This submenu allows you to configure certain “Plug and Play” and PCI options.

PC Health Status

This submenu allows you to monitor the hardware of your system.

OverClock Navigator Engine (O.N.E.)

ONE provides two powerful overclock engines, MOS & AOS for both overclock expertise and beginner.

Load Optimized Defaults

This selection allows you to reload the BIOS when problem occurs during system booting sequence. These configurations are factory settings optimized for this system. A confirmation message will be displayed before defaults are set.



Load Optimized Defaults (Y/N)? N

TForce P965 Deluxe

Set Supervisor Password

Setting the supervisor password will prohibit everyone except the supervisor from making changes using the CMOS Setup Utility. You will be prompted with to enter a password.



Enter Password:

Set User Password

If the Supervisor Password is not set, then the User Password will function in the same way as the Supervisor Password. If the Supervisor Password is set and the User Password is set, the “User” will only be able to view configurations but will not be able to change them.



Enter Password:

Save & Exit Setup

Save all configuration changes to CMOS (memory) and exit setup. Confirmation message will be displayed before proceeding.



SAVE to CMOS and EXIT (Y/N)? Y

Exit Without Saving

Abandon all changes made during the current session and exit setup. Confirmation message will be displayed before proceeding.



Quit Without Saving (Y/N)? N

TForce P965 Deluxe

Upgrade BIOS

This submenu allows you to upgrade bios.

BIOS UPDATE UTILITY (Y/N)? **N**

TForce P965 Deluxe

2 Standard CMOS Features

The items in Standard CMOS Setup Menu are divided into several categories. Each category includes no, one or more than one setup items. Use the arrow keys to highlight the item and then use the <PgUp> or <PgDn> keys to select the value you want in each item.

■ **Figure 2: Standard CMOS Setup**

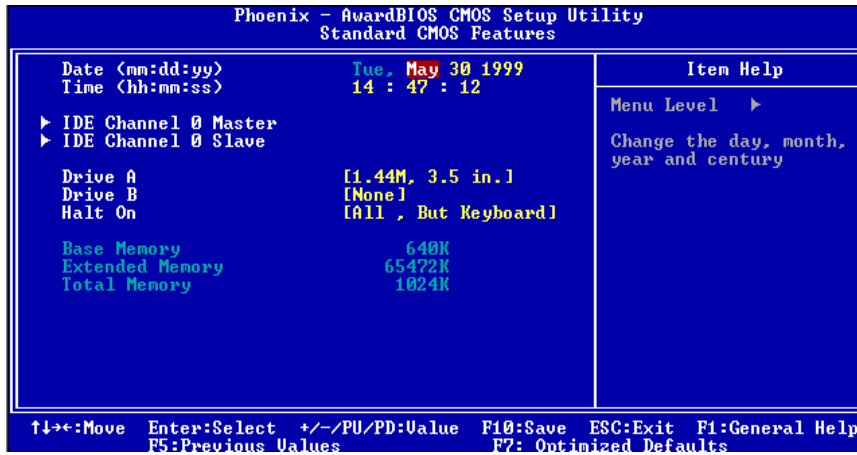

Main Menu Selections

This table shows the items and the available options on the Main Menu.

Item	Options	Description
Date	mm : dd : yy	Set the system date. Note that the 'Day' automatically changes when you set the date.
Time	hh : mm : ss	Set the system internal clock.
IDE Primary Master	Options are in its sub menu.	Press <Enter> to enter the sub menu of detailed options
IDE Primary Slave	Options are in its sub menu.	Press <Enter> to enter the sub menu of detailed options.
IDE Secondary Master	Options are in its sub menu.	Press <Enter> to enter the sub menu of detailed options.

TForce P965 Deluxe

Item	Options	Description
IDE Secondary Slave	Options are in its sub menu.	Press <Enter> to enter the sub menu of detailed options.
Drive A Drive B	360K, 5.25 in 1.2M, 5.25 in 720K, 3.5 in 1.44M, 3.5 in 2.88M, 3.5 in None	Select the type of floppy disk drive installed in your system.
Video	EGA/VGA CGA 40 CGA 80 MONO	Select the default video device.
Halt On	All Errors No Errors All, but Keyboard All, but Diskette All, but Disk/ Key	Select the situation in which you want the BIOS to stop the POST process and notify you.
Base Memory	N/A	Displays the amount of conventional memory detected during boot up.
Extended Memory	N/A	Displays the amount of extended memory detected during boot up.
Total Memory	N/A	Displays the total memory available in the system.

TForce P965 Deluxe

3 Advanced BIOS Features

■ Figure 3: Advanced BIOS Setup

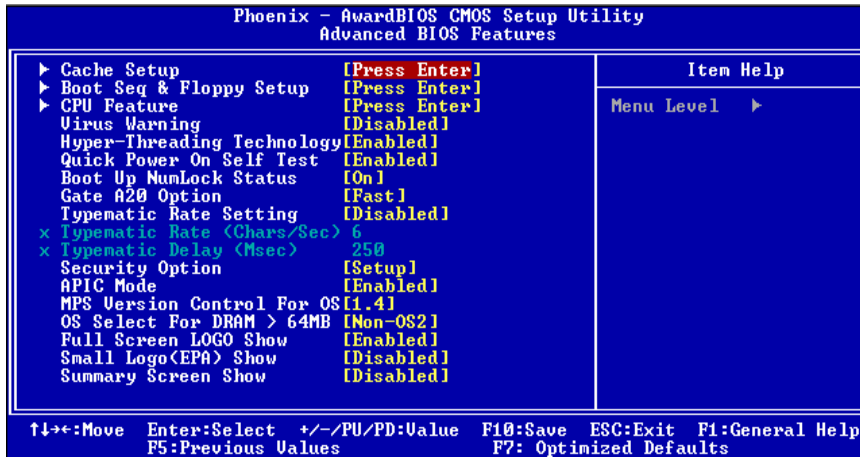

Cache Setup

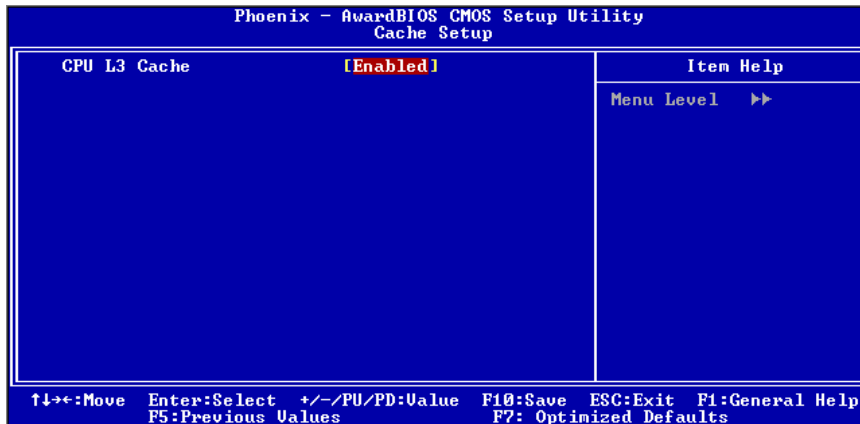

CPU L3 Cache

Depending on the CPU/chipset in use, you may be able to increase memory access time with this option.

Enabled (default) Enable cache.

Disabled Disable cache.

TForce P965 Deluxe

Boot Seq & Floppy Setup

This item allows you to setup boot sequence & Floppy.

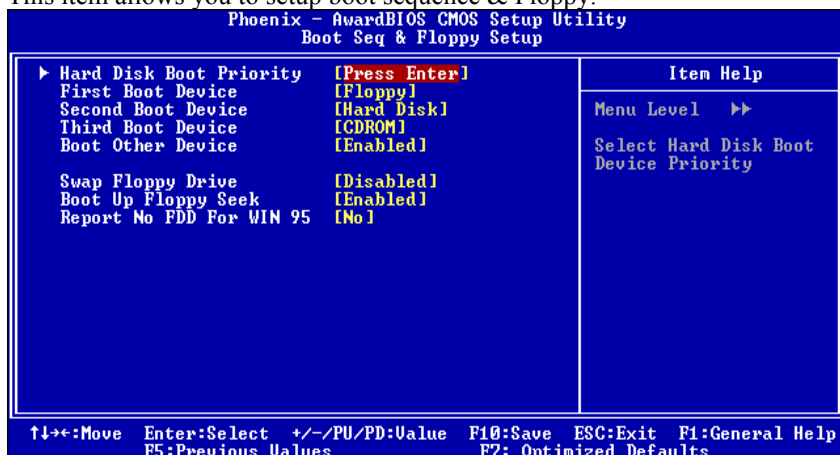

Hard Disk Boot Priority

The BIOS will attempt to arrange the Hard Disk boot sequence automatically. You can change the Hard Disk booting sequence here.

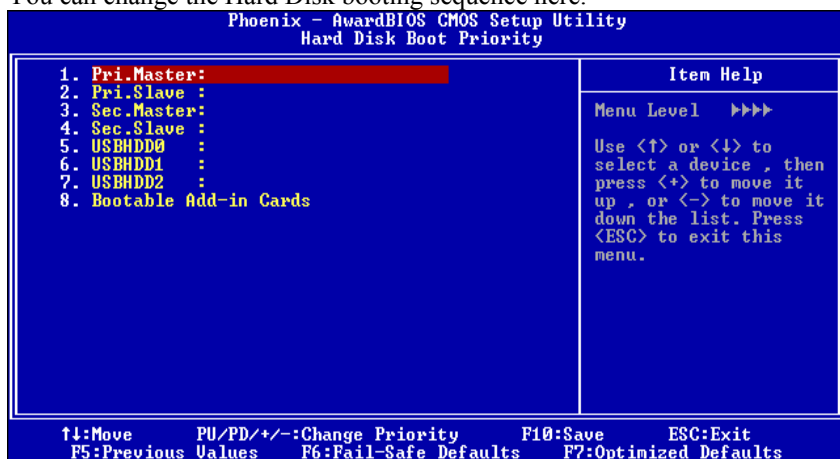

The Choices: Pri. Master, Pri. Slave, Sec. Master, Sec. Slave, USB HDD0, USB HDD1, USB HDD2, and Bootable Add-in Cards.

TForce P965 Deluxe

First/Second/Third Boot Device

The BIOS will attempt to load the operating system in this order.

The Choices: Floppy, LS120, HDD-0, SCSI, CDROM, HDD-1, HDD-2, HDD-3, ZIP100, LAN, HPT370, Disabled.

Boot Other Device

When enabled, BIOS will try to load the operating system from other device when it failed to load from the three devices above.

The Choices: Enabled (default), Disabled

Swap Floppy Drive

For systems with two floppy drives, this option allows you to swap logical drive assignments.

The Choices: Disabled (default), Enabled.

Boot Up Floppy Seek

When enabled, System will test the floppy drives to determine if they have 40 or 80 tracks during boot up. Disabling this option reduces the time it takes to boot-up.

The Choices: Enabled (default), Disabled.

Report NO FDD for Win95

This item allows you to select YES/NO to Report NO FDD for Win95.

The Choices: NO (default), Yes.

CPU Feature

TForce P965 Deluxe

Phoenix - AwardBIOS CMOS Setup Utility		
CPU Feature		
CPU Thermal Control	[Enabled]	Item Help
Delay Prior to Thermal	[16 Min]	
Thermal Management	[Thermal Monitor 1]	Menu Level >>
TM2 Bus Ratio	[0 X]	
TM2 Bus VID	[0.8375V]	
Limit CPUID MaxVal	[Disabled]	
C1E Function	[Auto]	
Execute Disable Bit	[Enabled]	
Virtualization Technology	[Enabled]	

F5: Previous Values F7: Optimized Defaults

CPU Thermal Control

This item can enable or disable the CPU Thermal function.

The Choices: Enabled (default), Disabled.

Delay Prior to Thermal

Set this item to enable the CPU Thermal function to engage after the specified time.

The Choices: 4 Min, 8 Min, **16Min** (default), 32 Min.

Thermal Management

This option allows you to select the way to control the “Thermal Management.”

The Choices: **Thermal Monitor 1** (default), Thermal Monitor 2.

TM2 Bus Ratio

This option represents the frequency (bus ratio) of the throttled performance state that will be initiated when the on-die sensor detects temperature increase.

Min= 0 Max= 255 Key in a DEC number.

The Choices: 0 X (default)

TM2 Bus VID

This option represents the voltage of the throttled performance state that will be initiated when the on-die sensor detects temperature increase.

The Choices: **0.8375V** (default), 0.8375-1.6000.

TForce P965 Deluxe

Limit CPUID MaxVal

Set Limit CPUID MaxVal to 3, it should be “Disabled” for Windows XP.

The Choices: Disabled (default), Enabled.

C1E Function

This item allows you to configure the Enhanced Halt State (C1E) function, which may reduce the power consumption of your system when the system is idle.

The Choices: Auto (default), Disabled.

Execute Disable Bit

This item allows you to configure the Execute Disabled Bit function, which protects your system from buffer overflow attacks.

The Choices: Enabled (default), Disabled.

Virtualization Technology

Virtualization Technology can virtually separate your system resource into several parts, thus enhance the performance when running virtual machines or multi interface systems.

The Choices: Enabled (default), Disabled.

TForce P965 Deluxe

Virus Warning

This option allows you to choose the VIRUS Warning feature that is used to protect the IDE Hard Disk boot sector. If this function is enabled and an attempt is made to write to the boot sector, BIOS will display a warning message on the screen and sound an alarm beep.

Disabled (default) Virus protection is disabled.

Enabled Virus protection is activated.

Hyper-Threading Technology

This option allows you to enable or disabled Hyper-Threading Technology. “Enabled” for Windows XP and Linux 2.4.x (OS optimized for Hyper-Threading Technology). “Disable” for other OS (OS not optimized for Hyper-Threading Technology).

The Choices: Enabled (default), Disabled.

Quick Power On Self Test

Enabling this option will cause an abridged version of the Power On Self-Test (POST) to execute after you power up the computer.

Disabled Normal POST.

Enabled (default) Enable quick POST.

Boot Up NumLock Status

Selects the NumLock State after the system switched on.

The Choices:

On (default) Numpad is number keys.

Off Numpad is arrow keys.

Gate A20 Option

Select if chipset or keyboard controller should control Gate A20.

Normal A pin in the keyboard controller controls GateA20.

Fast (default) Lets chipset control Gate A20.

Typematic Rate Setting

When a key is held down, the keystroke will repeat at a rate determined by the keyboard controller. When enabled, the typematic rate and typematic delay can be configured.

The Choices: Disabled (default), Enabled.

TForce P965 Deluxe

Typematic Rate (Chars/Sec)

Sets the rate at which a keystroke is repeated when you hold the key down.

The Choices: 6 (default), 8, 10, 12, 15, 20, 24, 30.

Typematic Delay (Msec)

Sets the delay time after the key is held down before it begins to repeat the keystroke.

The Choices: 250 (default), 500, 750, 1000.

Security Option

This option will enable only individuals with passwords to bring the system online and/or to use the CMOS Setup Utility.

System: A password is required for the system to boot and is also required to access the Setup Utility.

Setup (default): A password is required to access the Setup Utility only.

This will only apply if passwords are set from the Setup main menu.

APIC MODE

Selecting Enabled enables APIC device mode reporting from the BIOS to the operating system.

The Choices: Enabled (default), Disabled.

MPS Version Control For OS

The BIOS supports version 1.1 and 1.4 of the Intel multiprocessor specification.

Select version supported by the operation system running on this computer.

The Choices: 1.4 (default), 1.1.

OS Select For DRAM > 64MB

A choice other than Non-OS2 is only used for OS2 systems with memory exceeding 64MB.

The Choices: Non-OS2 (default), OS2.

TForce P965 Deluxe

Full Screen LOGO Show

This item allows you to enable/disable Full Screen LOGO Show.
The Choices: Enabled (default), Disabled.

Small Logo(EPA) Show

This item allows you to select whether the “Small Logo” shows. Enabled (default) “Small Logo” shows when system boots up. Disabled No “Small Logo” shows when system boots
The Choices: Disabled (default), Enabled.

Summary Screen Show

This item allows you to enable/disable the summary screen. Summary screen means system configuration and PCI device listing.
The Choices: Disabled (default), Enabled.

TForce P965 Deluxe

4 Advanced Chipset Features

This submenu allows you to configure the specific features of the chipset installed on your system. This chipset manage bus speeds and access to system memory resources, such as DRAM. It also coordinates communications with the PCI bus. The default settings that came with your system have been optimized and therefore should not be changed unless you are suspicious that the settings have been changed incorrectly.

■ **Figure 4: Advanced Chipset Setup**

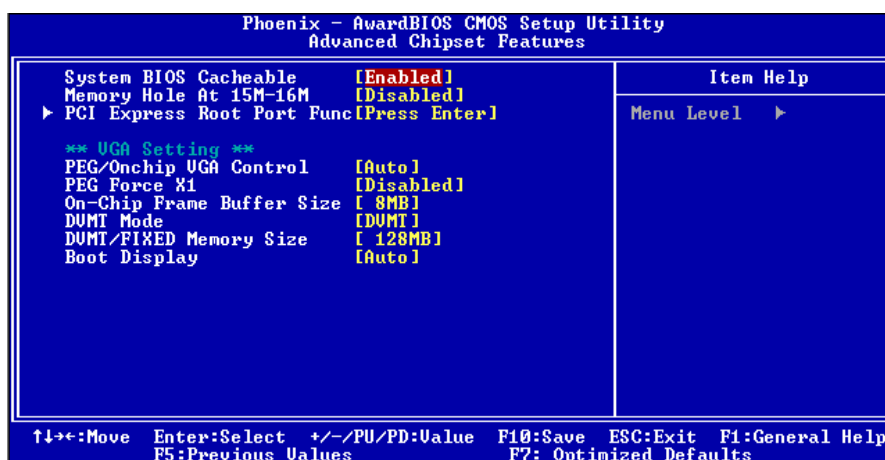

System BIOS Cacheable

Selecting the “Enabled” option allows caching of the system BIOS ROM at F0000h-FFFFFFh, which is able to improve the system performance. However, any programs that attempts to write to this memory block will cause conflicts and result in system errors.

The Choices: Enabled (default), Disabled.

Memory Hole At 15M-16M

You can reserve this area of system memory for ISA adapter ROM. When this area is reserved it cannot be cached. Check the user information of peripherals that need to use this area of system memory for the memory requirements.

The Choices: Disabled (default), Enabled.

TForce P965 Deluxe

PCI Express Root Port Func

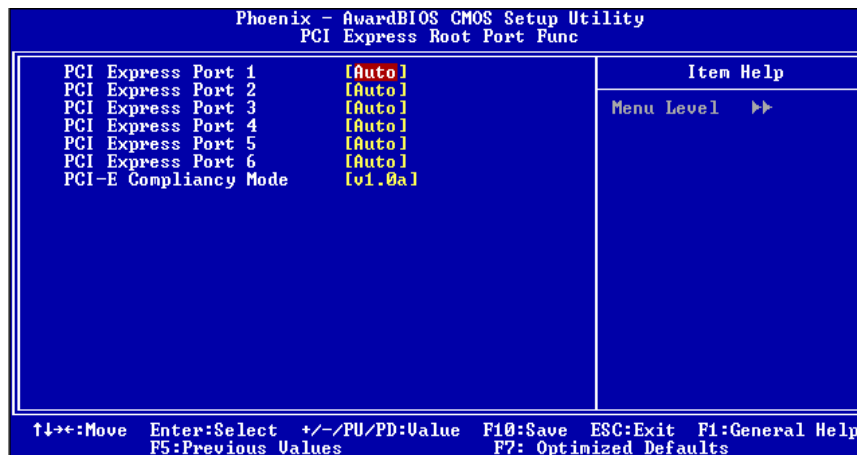

PCI Express Port 1 / 2 / 3 / 4 / 5 / 6

This item allows you to select the PCI Express Port.

The Choices: Auto (default), Enabled, Disabled.

PCI-E Compliancy Mode

This item allows you to select the PCI-E Compliancy Mode.

The Choices: v1.0a (default), v1.0.

VGA Settings

PEG/Onchip VGA Control

This item allows you to enable or disable PEG/On-chip VGA controller.

The Choices: Auto (default), Onchip VGA, PEG Port.

PEG Force X1

When using on-chip VGA, this item has to be set as X1.

Disabled (default) PCI Express X16

Enabled PCI Express X1

On-Chip Frame Buffer Size

This item will be different as your memory modules. When the memory size is decided, this frame buffer size will also be fixed.

The Choices: 8MB (default), 1MB.

TForce P965 Deluxe

UVMT Mode

This item allows you to select the UVMT mode.

The Choice: DVMT (default), FIXED, BOTH.

DVMT Memory Size

DVMT stands for „Dynamic Video Memory Technology“. This is an enhancement of the unified memory architecture (UMA) concept. DVMT will set the optimum amount of memory to be allocated for a balance between graphics and system performance. DVMT dynamically respond to system requirements and applications demands, by allocating the proper amount of display, texturing and buffer memory after the operating system has booted.

The Choices: 64MB, **128MB** (default), 224MB .

FIXED Memory Size

Fixed is a memory allocation method addition to the Unified Memory Architecture (UMA) concept, where a static amount of page-locked graphics memory is allocated during driver initialization. It will provide the total amount of graphics memory available to the system and is intended to provide the user with a guaranteed amount of graphics memory at all times.

The Choices: 64MB, **128MB** (default), 224 MB.

Boot Display

The Choices: Auto(default).

TForce P965 Deluxe

5 Integrated Peripherals

■ Figure 5. Integrated Peripherals

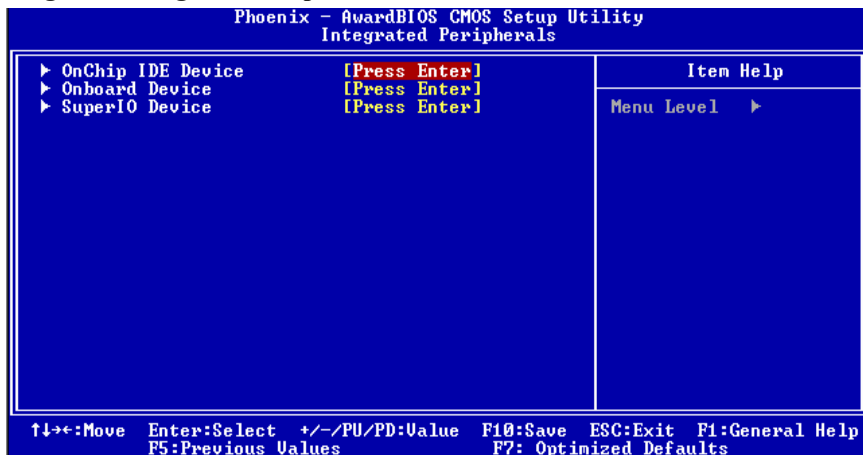

OnChip IDE Device

Highlight the “Press Enter” label next to the “OnChip IDE Device” label and press enter key will take you a submenu with the following options:

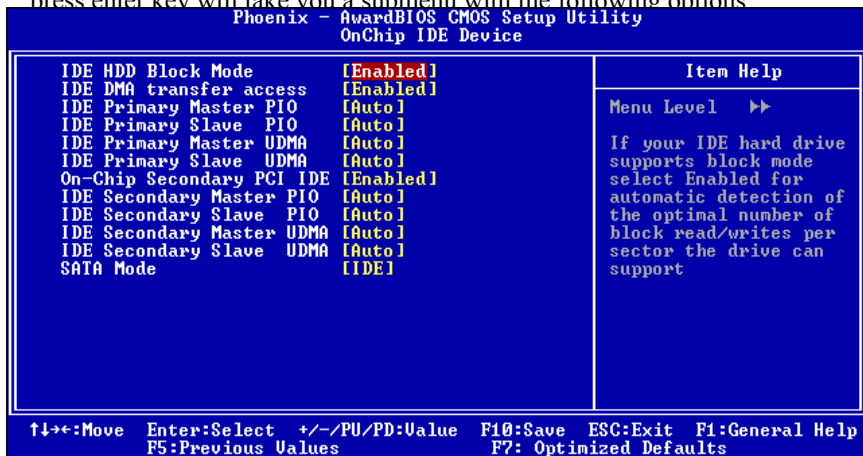

TForce P965 Deluxe

IDE HDD Block Mode

Block mode is also called block transfer, multiple commands, or multiple sectors read / write. If your IDE hard drive supports block mode (most new drives do), select Enabled for automatic detection of the optimal number of block mode (most new drives do), select Enabled for automatic detection of the optimal number of block read / write per sector where the drive can support.

The Choices: Enabled (default), Disabled.

IDE DMA Transfer Access

This item allows you to enable or disable the IDE DMA transfer access.

The Choices: Enabled (default), Disabled.

IDE Primary/Secondary/Master/Slave PIO

The IDE PIO (Programmed Input / Output) fields let you set a PIO mode (0-4) for each of the IDE devices that the onboard IDE interface supports. Modes 0 to 4 will increase performance progressively. In Auto mode, the system automatically determines the best mode for each device.

The Choices: Auto (default), Mode0, Mode1, Mode2, Mode3, Mode4.

On-chip Secondary PCI IDE

This item allows you to enable or disable the primary / secondary IDE Channel.

The Choices: Enabled (Default), Disabled.

IDE Primary/Secondary/Master/Slave UDMA

Ultra DMA function can be implemented if it is supported by the IDE hard drives in your system. As well, your operating environment requires a DMA driver (Windows 95 or OSR2 may need a third party IDE bus master driver). If your hard drive and your system software both support Ultra DMA, select Auto to enable BIOS support.

The Choices: Auto (default), Disabled.

SATA Mode

This item allows you to select SATA Mode.

The Choices: IDE (default), RAID, AHCI.

TForce P965 Deluxe

Onboard Device

Highlight the “Press Enter” label next to the “Onboard Device” label and press the enter key will take you a submenu with the following options:

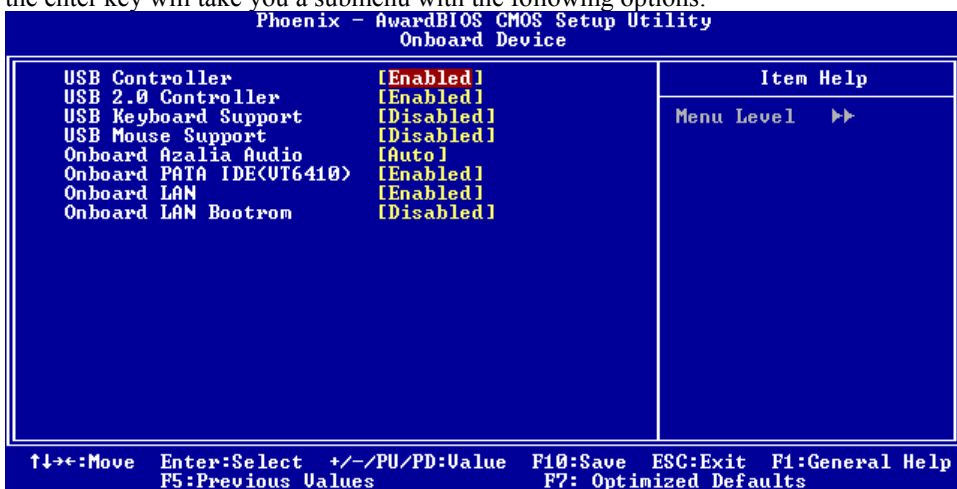

USB Controller

Select enabled if your system contains a Universal Serial Bus (USB) controller and you use USB peripherals.

The Choices: Enabled (default), Disabled

USB 2.0 Controller

This entry is to enabled/ disabled EHCI controller.

The Choices: Enabled (default), Disabled.

USB Keyboard Support

This item allows you to enable or disable the USB Keyboard Legacy Support.

Enabled Enable USB Keyboard Support.

Disabled (default) Disable USB Keyboard Support.

USB Mouse Support

This item allows you to enable or disable the USB Mouse Legacy Support.

Enabled Enable USB Mouse Support.

Disabled (default) Disable USB Mouse Support.

TForce P965 Deluxe

Onboard Azalia Audio

This item allows you to enable or disable to support Onboard Azalia Audio function.

The Choices: Auto (default).

Onboard PATA IDE<VT6410>

The Choices: Enabled (default), Disabled

Onboard LAN

This item allows you to enable or disable the Onboard LAN.

The Choices: Enabled (default), Disabled.

Onboard LAN Boot ROM

This item allows you to enable or disable the Onboard LAN Boot ROM.

The Choices: Disabled (default), Enabled.

Super IO Device

Press Enter to configure the Super I/O Device.

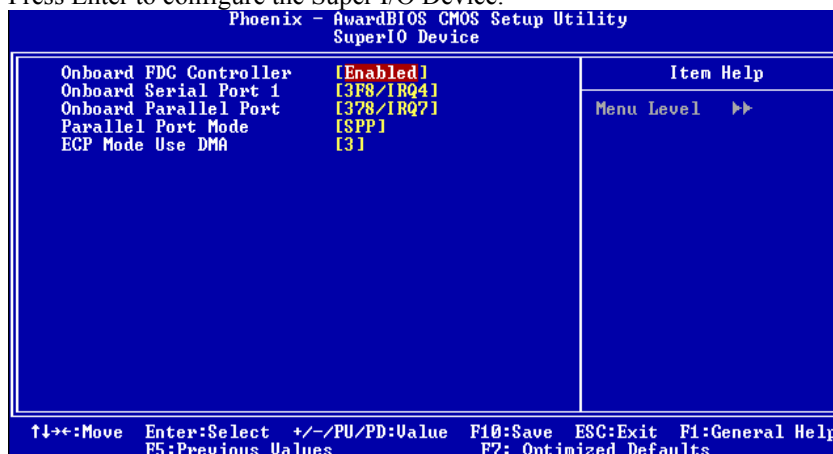

Onboard FDC Controller

Select enabled if your system has a floppy disk controller (FDC) installed on the system board and you wish to use it. If you installed another FDC or the system uses no floppy drive, select disabled in this field.

The Choices: Enabled (default), Disabled.

Onboard Serial Port 1

Select an address and corresponding interrupt for the first and second serial

TForce P965 Deluxe

ports.

The Choices: 3F8/IRQ4 (default), Disabled, 2F8/IRQ3, 3E8/IRQ4, 2E8/IRQ3, Auto.

Onboard Parallel Port

This item allows you to determine access onboard parallel port controller with which I/O Address.

The Choices: 378/IRQ7 (default), 278/IRQ5, 3BC/IRQ7, Disabled.

Parallel Port Mode

This item allows you to determine how the parallel port should function. The default value is SPP.

The Choices:

SPP (default)	Using Parallel port as Standard Printer Port.
EPP	Using Parallel Port as Enhanced Parallel Port.
ECP	Using Parallel port as Extended Capabilities Port.
ECP+EPP	Using Parallel port as ECP & EPP mode.

ECP Mode Use DMA

Select a DMA Channel for the port.

The Choices: 3 (default), 1.

TForce P965 Deluxe

6 Power Management Setup

The Power Management Setup Menu allows you to configure your system to utilize energy conservation and power up/power down features.

■ **Figure 6. Power Management Setup**

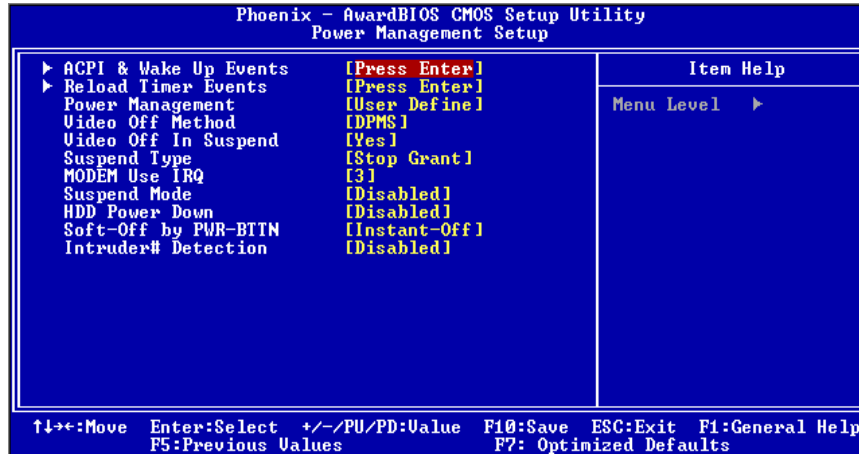

ACPI & Wake Up Events

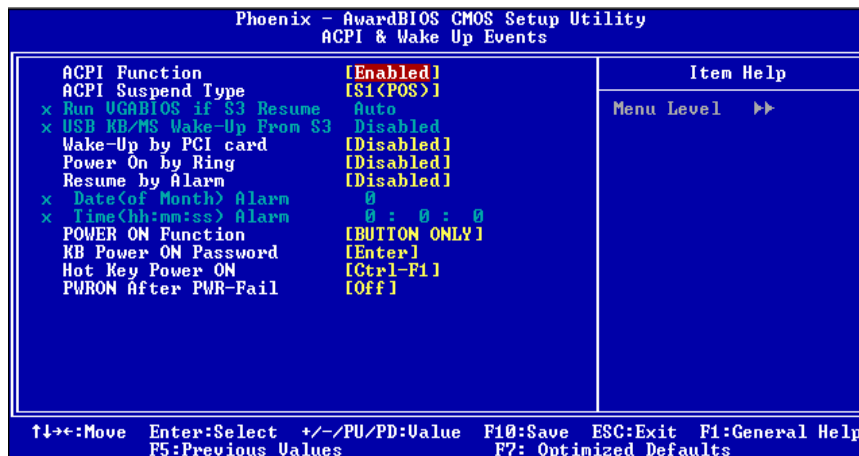

TForce P965 Deluxe

ACPI Function

This item displays the status of the Advanced Configuration and Power Management (ACPI).

The Choices: Enabled (default), Disabled.

ACPI Suspend Type

The item allows you to select the suspend type under the ACPI operating system.

The Choices: **S1 (POS)** (default) Power on Suspend
 S3 (STR) Suspend to RAM
 S1 & S3 POS+STR

Run VGABIOS if S3 Resume

Choosing Enabled will make BIOS run VGA BIOS to initialize the VGA card when system wakes up from S3 state. The system resume time is shortened if you disable the function, but system will need AGP driver to initialize the card. So, if the AGP driver of the VGA card does not support the initialization feature, the display may work abnormally or not function after S3.

The Choices: Auto (default), Yes, No.

USB KB/MS Wake-Up From S3

This item allows you to enable or disabled the USB keyboard wake up from S3 function.

The Choices: Disabled (default), Enabled.

Wake-Up by PCI card

When you select "Enable", a PME signal from PCI card returns the system to Full On state.

The Choices: Enabled, Disabled (default).

Power On by Ring

An input signal on the serial Ring Indicator (RI) line (in other words, an incoming call on the modem) awakens the system from a soft off state.

The Choices: Enabled, Disabled (default).

Resume by Alarm

This function is for setting date and time for your computer to boot up. When enabled, you can choose the date and time of system resume.

The Choices: Disabled (default), Enabled.

Date (of Month) Alarm

You can choose which month the system will boot up.

TForce P965 Deluxe

Time (hh:mm:ss) Alarm

You can choose the system boot up time, input hour, minute and second to specify.

Note: If you have change the setting, you must let the system boot into operating system, before this function will work.

POWER ON Function

This item allows you to choose the power on method.

The Choices: **Button Only** (default), Password, Hot Key, Mouse/Click, Mouse Double/Click, Any Key, Keyboard 98.

KB Power ON Password

Input password and press Enter to set the Keyboard power on password.

Hot Key Power ON

Choose the Hot Key combination to boot up the system.

The Choices: **Ctrl-F1** (default), Ctrl-F2, Ctrl-F3, Ctrl-F4, Ctrl-F5, Ctrl-F6, Ctrl-F7, Ctrl-F8, Ctrl-F9, Ctrl-F10, Ctrl-F11, and Ctrl-F12.

POWER After PWR-Fail

This setting specifies how your system should behave after a power fail or interrupts occurs. By choosing off will leave the computer in the power off state. Choosing On will reboot the computer. Former-Sts will restore the system to the status before power failure or interrupt occurs.

The Choices: **Off** (default), On, Former-Sts.

Reload Timer Events

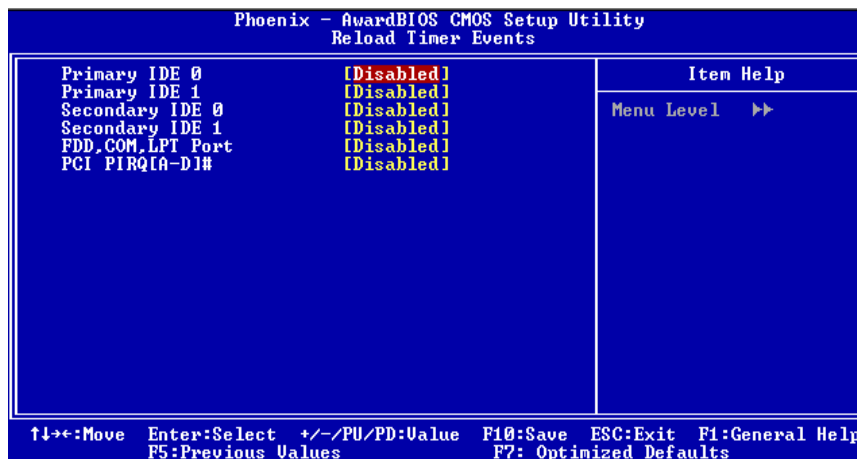

TForce P965 Deluxe

Primary/Secondary IDE 0/1

You can enable or disable Primary or Secondary RAID 0 or RAID 1 function under this item.

The Choices: Disabled (default), Enabled.

FDD, COM, LPT Port

You can enable or disable FDD, COM, and LPT port under this item.

The Choices: Disabled (default), Enabled.

PCI PIRQ [A-D]#

You can enable or disable PCI PIRQ [A-D]# under this item.

The Choices: Disabled (default), Enabled.

Power Management

This category allows you to select the power saving method and is directly related to the following modes:

1. HDD Power Down.
2. Suspend Mode.

There are three options of Power Management, three of which have fixed mode settings

Min. Power Saving

Minimum power management.

Suspend Mode = 1 hr.

HDD Power Down = 15 min

Max. Power Saving

Maximum power management only available for sl CPU's.

Suspend Mode = 1 min.

HDD Power Down = 1 min.

User Define (default)

Allow you to set each option individually.

When you choose user define, you can adjust each of the item from 1 min. to 1 hr. except for HDD Power Down which ranges from 1 min. to 15 min.

TForce P965 Deluxe

Video Off Method

This option determines the manner when the monitor goes blank.

V/H SYNC+Blank

This selection will cause the system to turn off the vertical and horizontal synchronization ports and write blanks to the video buffer.

Blank Screen

This option only writes blanks to the video buffer.

DPMS (default)

Initial display power management signaling.

Video Off In Suspend

This item determines the monitor status when the system is in Suspend mode.

The Choices: Yes (default), No.

Suspend Type

Select the Suspend Type.

The Choices: **Stop Grant** (default), PwrOn Suspend.

Modem Use IRQ

This determines the IRQ, which can be applied in MODEM use.

The Choices: **3** (default), 4, 5, 7, 9, 10, 11, NA.

Suspend Mode

The item allows you to adjust the system idle time before suspend.

The Choices: **Disabled** (default), 1 Min, 2 Min, 4 Min, 6 Min, 8 Min, 10 Min, 20 Min, 30 Min, 40 Min, 1 Hour.

HDD Power Down

When enabled, the hard-disk drives will power down after a set time of system inactivity. All other devices remain active.

The Choices: **Disabled** (default), 1 Min, 2 Min, 3 Min, 4 Min, 5 Min, 6 Min, 7 Min, 8 Min, 9 Min, 10 Min, 11 Min, 12 Min, 13 Min, 14 Min, 15Min.

TForce P965 Deluxe

Soft-Off by PWR-BTN

This item determines the behavior of system power button. Instant off turn off the power immediately, and Delay 4 Sec. will require you to press and hold the power button for 4 seconds to cut off the system power.

The Choices: Delay 4 Sec, **Instant-Off** (default).

Intruder # Detection

This item allows you to enable or disable intruder detection function.

The Choices: Disabled (default), Enabled.

TForce P965 Deluxe

7 PnP/PCI Configurations

This section describes configuring the PCI bus system. PCI, or Personal Computer Interconnect, is a system which allows I/O devices to operate at speeds nearing the speed of the CPU itself uses when communicating with its own special components. This section covers some very technical items and it is strongly recommended that only experienced users should make any changes to the default settings.

■ **Figure 7: PnP/PCI Configurations**

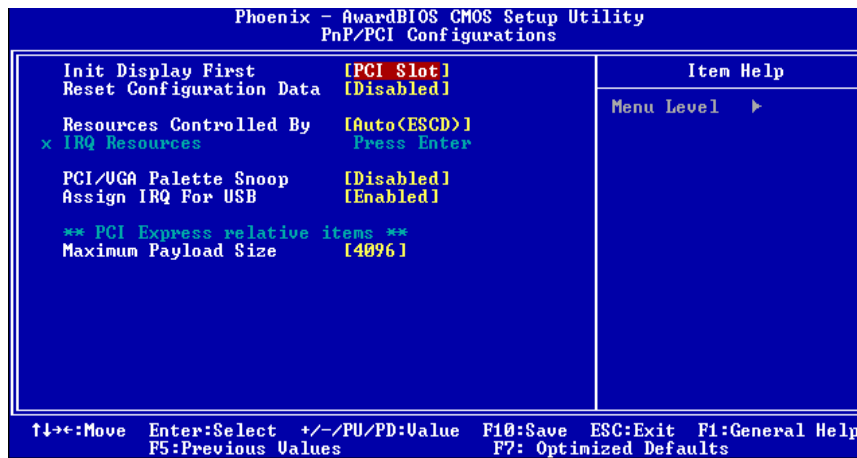

Init Display First

This item allows you to decide to active whether PCI Slot or on-chip VGA first. The Choices: PCEX, PCI Slot (default).

Reset Configuration Data

The system BIOS supports the PnP feature which requires the system to record which resources are assigned and protects resources from conflict. Every peripheral device has a node, which is called ESCD. This node records which resources are assigned to it. The system needs to record and update ESCD to the memory locations. These locations are reserved in the system BIOS. If the Disabled (default) option is chosen, the system's ESCD will update only when the new configuration varies from the last one. If the Enabled option is chosen, the system is forced to update ESCDs and then is automatically set to the "Disabled" mode.

TForce P965 Deluxe

The above settings will be shown on the screen only if “Manual” is chosen for the resources controlled by function.

Legacy is the term, which signifies that a resource is assigned to the ISA Bus and provides non-PnP ISA add-on cards. PCI / ISA PnP signify that a resource is assigned to the PCI Bus or provides for ISA PnP add-on cards and peripherals.

The Choices: Disabled (default), Enabled.

Resources Controlled By

By Choosing “**Auto(ESCD)**” (default), the system BIOS will detect the system resources and automatically assign the relative IRQ and DMA channel for each peripheral. By Choosing “Manual”, the user will need to assign IRQ & DMA for add-on cards. Be sure that there are no IRQ/DMA and I/O port conflicts.

The Choices: Auto (ESCD) (default), Manual.

IRQ Resources

This submenu will allow you to assign each system interrupt a type, depending on the type of device using the interrupt. When you press the “Press Enter” tag, you will be directed to a submenu that will allow you to configure the system interrupts. This is only configurable when “Resources Controlled By” is set to “Manual”.

IRQ-3	assigned to PCI Device
IRQ-4	assigned to PCI Device
IRQ-5	assigned to PCI Device
IRQ-7	assigned to PCI Device
IRQ-9	assigned to PCI Device
IRQ-10	assigned to PCI Device
IRQ-11	assigned to PCI Device
IRQ-12	assigned to PCI Device
IRQ-14	assigned to PCI Device
IRQ-15	assigned to PCI Device

PCI / VGA Palette Snoop

Some old graphic controllers need to “snoop” on the VGA palette and then map it to their display as a way to provide boot information and VGA compatibility. This item allows such snooping to take place.

The Choices: Disabled (default), Enabled

TForce P965 Deluxe

Assign IRQ For USB

This item allows the users to choose which IRQ to assign for the USB.

The Choices: Enabled (default), Disabled.

Maximum Payload Size

Set the maximum payload size for Transaction packets (TLP).

The Choice: 4096 (default.), 128, 256, 512, 1024, 2048.

8 PC Health Status

■ Figure 8: PC Health Status

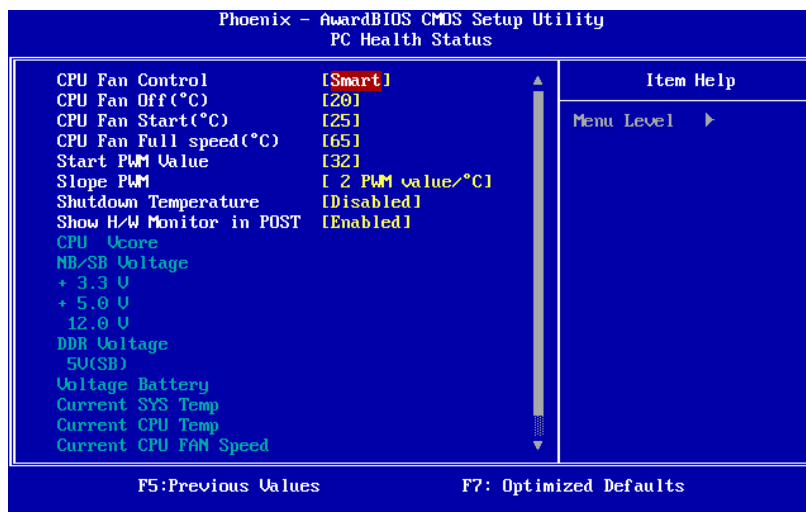

CPU FAN Control

Choose "smart" to reduce the noise caused by CPU FAN.

The Choices: Smart (default), Always On.

CPU Fan Off<°C>

If the CPU Temperature is lower than the set value, FAN will turn off.

The Choices: 20 (default).

Min=0 Max=127 Key in a DEC number.

CPU Fan Start<°C>

CPU fan starts to work under smart fan function when arrive this set value.

The Choices: 25(default).

Min=0 Max=127 Key in a DEC number.

TForce P965 Deluxe

CPU Fan Full speed <°C>

When CPU temperature is reach the set value, the CPU fan will work under Full Speed.

The Choices: 65(default).

Min=0 Max=127 Key in a DEC number.

Start PWM Value

When CPU temperature arrives to the set value, the CPU fan will work under Smart Fan Function mode. The range is from 0~127, with an interval of 1.

The Choices: 32 (default).

Min=0 Max=127 Key in a DEC number.

Slope PWM

Increasing the value of slope PWM will raise the speed of CPU fan.

The Choices: 1 PWM Value/°C, 2 PWM Value/°C(default), 4 PWM Value/°C, 8 PWM Value/°C,16 PWM Value/°C,32 PWM Value/°C, 64PWM Value/°C.

Shutdown Temperature

This item allows you to set up the CPU shutdown Temperature. This item is only effective under Windows 98 ACPI mode.

The Choices: Disabled (default) , 65°C / 140°F, 70°C / 149°F, 75°C / 158°F.

Show H/W Monitor in POST

If you computer contains a monitoring system, it will show PC health status during POST stage. The item offers several different delay times.

The Choices: Enabled (default), Disabled.

CPU Vcore, NB/SB/DDR Voltage, +3.3V, +5.0V, 12.0V, DDR Voltage, 5V (SB), Voltage Battery

Detect the system's voltage status automatically.

Current SYS Temp

This field displays the current temperature of system.

TForce P965 Deluxe

Current CPU Temp

This field displays the current temperature of CPU.

Current CPU FAN Speed

This field displays the current speed of CPU fan.

Current SYS FAN Speed

This field displays the current speed SYSTEM fan.

TForce P965 Deluxe

9 Over Clock Navigator

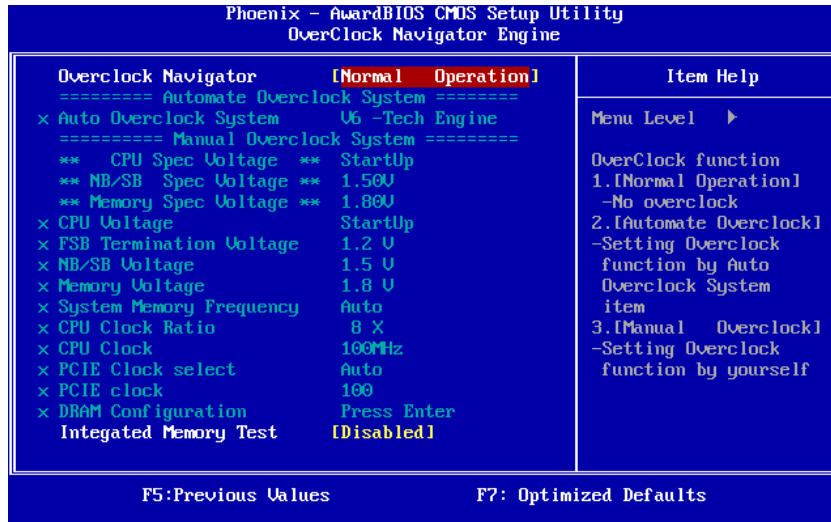

OverClock Navigator

OverClock Navigator is designed for beginners in overclock field.

Based on many test and experiments from Biostar Engineer Team, OverClock Navigator provides 3 default overclock configurations that are able to raise the system performance

The Choices: Normal Operation (default), Automate Overclock, Manual Overclock

TForce P965 Deluxe

Auto OverClock System

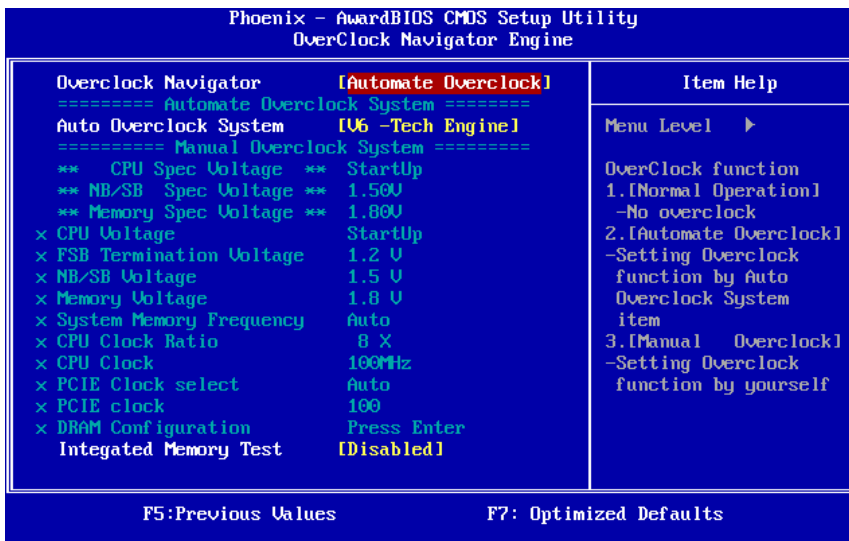

The Overclock Navigator provides 3 different engines helping you to overclock your system. These engines will boost your system performance to different level.

The Choices:

V6 Tech Engine

This setting will raise about 5%~10% of whole system performance.

V8 Tech Engine

This setting will raise about 15%~25% of whole system performance.

V12 Tech Engine

This setting will raise about 25%~30% of whole system performance.

Cautions:

1. Not every AMD CPU performs the above overclock setting ideally; the difference may vary with the installed CPU model.
2. From BET experiment, the Atholon64 FX CPU is not suitable for this A.O.S. feature.

TForce P965 Deluxe

Manual Overclock System (M.O.S.)

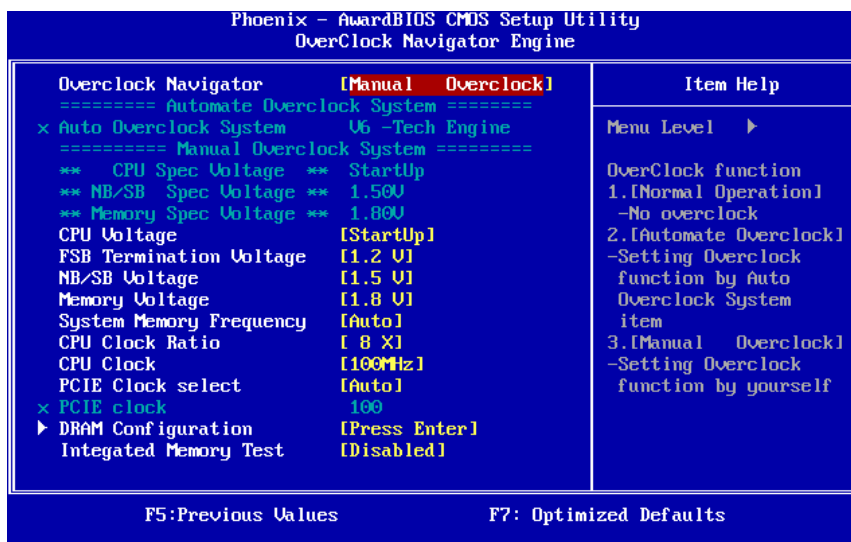

MOS is designed for experienced overclock users.
It allows users to customize personal overclock setting.

Note:

Based on our test results; the overclock function achieved the best performance on AMD 3000+ CPU

CPU Voltage

This item allows you to select CPU Voltage Control.

The Choices: StartUp (default), 2.0000, 1.9750, 1.9500, 1.9250, 1.9000, 1.8750, 1.8500, 1.8250 etc.

FSB Termination Voltage

The Choices: 1. 2V (default) , 1.3V, 1.4V, 1.5V.

NB/SB Voltage

The Choices: 1.5V (default), 1.6V, 1.7V, 1.8V.

Memory Voltage

The Choices: 1.8V (default), 2.0V, 2.1V, 2.2 V.

TForce P965 Deluxe

System Memory Frequency

The Choices: Auto (default), 533MHz, 667MHz, 800MHz.

CPU Clock Ratio

The Choices: 8X(default).
Min=8 Max=50 Key in a DEC number.

CPU Clock

The Choices: 100MHz(default).
Min=100 Max=333 Key in a DEC number.

PCIE Clock select

The Choices: Auto (default), Upto CPU, Fixed 100, Manual

PCIE Clock

Display the PCIE Clock frequency

DRAM Configuration

Phoenix - AwardBIOS CMOS Setup Utility		
DRAM Configuration		
DRAM Timing Selectable	[By SPD]	Item Help
CAS Latency Time	[Auto]	
DRAM RAS# to CAS# Delay	[Auto]	Menu Level >>
DRAM RAS# Precharge	[Auto]	
Precharge dealy (tRAS)	[Auto]	
TWR	[Auto]	
TWTR	[Auto]	
TRRD	[Auto]	
TRTP	[Auto]	

↑↓←→:Move Enter:Select +/-/PU/PD:Ualue F10:Save ESC:Exit F1:General Help
F5:Previous Values F7: Optimized Defaults

DRAM Timing Selectable

The Choices: By SPD (Default), Manual.

TForce P965 Deluxe

CAS# Latency Time

The Choices: **Auto** (Default), 3, 4, 5, 6, 7, 8, 9, 10.

DRAM RAS# to CAS# Delay

The Choices: **Auto** (Default), 3, 4, 5, 6, 7.

DRAM RAS# Precharge

The Choices: **Auto** (Default), 3, 4, 5, 6, 7.

Precharge delay <tRAS>

The Choices: **Auto** (Default), 9, 10, 11, 12, 13, 14, 15, 16, 17, 18, 19, 20, 21, 22, 23.

TWR

The Choices: **Auto** (Default), 3, 4, 5, 6, 7, 8, 9, 10, 11, 12, 13, 14, 15.

TWTR

The Choices: **Auto** (Default), 2, 3, 4, 5, 6, 7, 8, 9, 10, 11, 12, 13, 14, 15.

TRRD

The Choices: **Auto** (Default), 2, 3, 4, 5, 6, 7, 8, 9, 10, 11, 12, 13, 14, 15.

TRTP

The Choices: **Auto** (Default), 2, 3, 4, 5, 6, 7, 8, 9, 10, 11, 12, 13, 14, 15.

Integrated Memory Test

Integrated Memory Test allows users to test memory module compatibilities without additional device or software.

Step 1:

This item is disabled on default; change it to “Enable” to precede memory test.

TForce P965 Deluxe

```

Phoenix - AwardBIOS CMOS Setup Utility
OverClock Navigator Engine

Overclock Navigator [Normal Operation]
===== Automate Overclock System =====
x Auto Overclock System U6 -Tech Engine
===== Manual Overclock System =====
** CPU Spec Voltage ** StartUp
** NB/SB Spec Voltage ** 1.500
** Memory Spec Voltage ** 1.800
x CPU Voltage StartUp
x FSB Termination Voltage 1.2 U
x NB/SB Voltage 1.5 U
x Memory Voltage 1.8 U
x System Memory Frequency Auto
x CPU Clock Ratio 8 X
x DRAM Configuration Press Enter
Integrated Memory Test [Disabled]

Item Help
Menu Level ▶
OverClock function
1.[Normal Operation]
-No overlock
2.[Automate Overclock]
-Setting Overclock
function by Auto
Overclock System
item
3.[Manual Overclock]
-Setting Overclock
function by yourself

↑↓+:-Move Enter:Select +/-/PU/PD:Ualue F10:Save ESC:Exit F1:General Help
F5:Previous Values F7: Optimized Defaults
    
```

TForce P965 Deluxe

Step 2:

When the process is done, change the setting back from “Enabled” to “Disabled” to complete the test.

```
Phoenix - AwardBIOS CMOS Setup Utility
OverClock Navigator Engine

Overclock Navigator [Normal Operation]
===== Automate Overclock System =====
x Auto Overclock System U6 -Tech Engine
===== Manual Overclock System =====
** CPU Spec Voltage ** StartUp
** NB/SB Spec Voltage ** 1.500
** Memory Spec Voltage ** 1.800
x CPU Voltage StartUp
x FSB Termination Voltage 1.2 U
x NB/SB Voltage 1.5 U
x Memory Voltage 1.8 U
x System Memory Frequency Auto
x CPU Clock Ratio 8 X
x DRAM Configuration Press Enter
Integated Memory Test [Enabled]

Item Help
Menu Level ▶

↑↓→:Move Enter:Select +/-/PU/PD:Ualue F10:Save ESC:Exit F1:General Help
F5:Previous Values F7: Optimized Defaults
```

TForce P965 Deluxe

10 CMOS Reload Program (C.R.P.)

The CMOS Reload Program (CRP) allows you to save different CMOS settings into BIOS-ROM. You may reload any saved CMOS setting to change system configurations. Moreover, you may save your ideal overclock setting for easier overclocking. There are 50 sets record addresses in total, and you may name the saved CMOS data individually.

